



***sutton**tools*

DRILLS

▪ Metal ▪ Wood ▪ Masonry ▪ Glass & Tile

Catalogue Code	Page	Wood						Metal								Masonry								Glass & Tile						
		Hard wood & soft wood	Wood & nails	Plywood	Chipboard	MDF	Laminated particle board	Steel	Hard Steel	Stainless steel	Aluminium	Copper & Brass	Cast iron	Sheet metal	Metal pipes	Plaster board	Cement sheet	Ceramics & Tiles	Hebel	Brick	Concrete	Reinforced Concrete	Stone	Granite	Marble	PVC Plastics	Acrylic	Glass	Fibreglass	Carbon Fibre
D101	30	○	○	○	○	○		●			●	●		○	○	○										○				
D103	27	○	○	○	○	○		●	○	○	○	○	●	○	○	○										○				
D105	33	○	○	○	○	○	○	●			●	●		○	○	○										○				
D108	36	○	○	○	○	○		●	●	●	○	○	●	○	●	○										○				
D110	44	○	○	○	○			●			●	●	○	○	○	○										○				
D125	49							●			○	○	●													○				
D129	32	○	○	○	○	○		●			●	●	○	○	○	○										○				
D130	49							●	○	●	○	○		●												○				
D134	49							●			●	●	●													○				
D183	40	●		●	○	○	○	●			●	●	●	○												○				
D184	34	○	○	○	○	○	○	●		●	●	●	○	●	○											○				
D185	35							●		●		●	●	○												●				
D187	45	○	○	○	○	○		●			●	●	○	○												○				
D188	46	○	○	○	○			●			○	○	○													○				
D500	60	●		●	●	●	○								○															
D501	54	●		○	○	●	○																							
D510	56	●		○	○	○																								
D514	55	●		○	○	○																								
D600	74														●	●		●	●	●		●	○	○						
D604	79																○		●							○	○	●	○	○
D605	80																●					○	●	●			●	○	○	
D606	75														●	●		●	●	●		●	○	○						
D609	76														●	●		●	●	●		●	○	○						
D610	78	○	○	○	○	○		○	○	○	○	○	○	●	●	●	○	○	○	○	○	○	○	○	○		○			
D612	62															●		●	●	●		●	○							
D623	64														●		●	●	●	●	●	●	●	○						

● Optimal ○ Effective

DRILLS

Drills Index

- | | | | |
|----|---|----|---|
| 73 | Chisels SDS Plus | 45 | Drills Long Series – Extra Long Reach |
| 72 | Chisels SDS Plus / SDS Max | 74 | Drills Masonry |
| 81 | Core Bits Diamond | 75 | Drills Masonry – Bulk Pack |
| 80 | Core Bits Diamond – <i>Blue Ceram</i> | 77 | Drills Masonry – DIY Range |
| 79 | Core Bits Diamond – <i>Dry Cut</i> | 75 | Drills Masonry – Hammer Hex, Anti-Slip |
| 71 | Core Bits TCT – SDS Max | 76 | Drills Masonry – Impact |
| 70 | Core Bits TCT – SDS Plus | 66 | Drills Masonry SDS Max – Reo Extreme 10 Cut |
| 56 | Drills Auger Bits | 65 | Drills Masonry SDS Max – Reo Pro 3 Cut |
| 55 | Drills Auger Bits – 4 Flute | 67 | Drills Masonry SDS Max – Speeduster 10 Cut |
| 57 | Drills Auger Bits – Garden | 62 | Drills Masonry SDS Plus – 2 Cut |
| 57 | Drills Auger Bits – Landscape | 68 | Drills Masonry SDS Plus – 2 Cut Clean Breakout |
| 60 | Drills Brad Points | 63 | Drills Masonry SDS Plus – 4 Cut |
| 58 | Drills Forstner Bits | 64 | Drills Masonry SDS Plus – Reo Pro 3 Cut |
| 79 | Drills Glass & Tile | 69 | Drills Masonry SDS Plus – Stop Drills |
| 32 | Drills Jobber – <i>Blue Bullet</i> | 45 | Drills Mini Hand Drill |
| 30 | Drills Jobber Bulk Pack – <i>Silver Bullet</i> | 78 | Drills Multi-Purpose |
| 39 | Drills Jobber Bulk Pack – TiN | 49 | Drills Panel & Rivet – Double Ended |
| 36 | Drills Jobber – <i>Cobalt</i> | 50 | Drills Panel & Rivet – Hex Shank |
| 35 | Drills Jobber – <i>INOX</i> | 48 | Drills Panel & Rivet – Single Ended |
| 37 | Drills Jobber – Left Hand Cobalt | 43 | Drills Quickbits® - Changeable |
| 28 | Drills Jobber Sets | 42 | Drills Quickbits® - Fixed Shank |
| 26 | Drills Jobber Sets – Imperial | 59 | Drills Quickbits® - Hinge Mate |
| 24 | Drills Jobber Sets – Metric | 47 | Drills Reduced Shank |
| 40 | Drills Jobber – Supabit Impact | 46 | Drills Reduced Shank – Sets |
| 38 | Drills Jobber – TiN | 54 | Drills Spade Bits |
| 33 | Drills Jobber – <i>Viper</i> | 51 | Drills Spot Weld |
| 34 | Drills Jobber – <i>Viper Plus</i> | 52 | Drills Step Drills |
| 44 | Drills Long Series | 82 | Drills Technical Information |

suttontools

Section
Index



D101 SM1



D101 SM2



D101 SM3

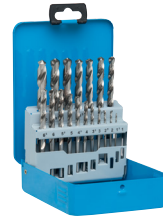

D101 MTL SM2



D101 MTL SM3



D101 SRKM2



D101 SRKM3



D101 SRK20



D101 SM7



D102 SM1



D102 SM2



D102 SM3



D102 SM30



D102 SM41



D102 SM8



D102 SM99



D102 SM101



D105 SLV7M



D105 SLV10M



D105 SLV13M



D105 V2M



D105 V3M



D179 SM2



D179 SM3



D180 SM2



D180 SM3



D109 SM2



D109 SM3



D103 SM3



suttontools



Silver Bullet Drills
General purpose drill bit designed for machine and hand held drilling in a wide range of ferrous and non-ferrous materials.

Blue Bullet Drills
The blue finish reduces chip build up on the cutting edge and is a better choice when drilling ferrous materials.

Viper Drills
The Viper bit point design is 118° split point is self-centring. It minimises wandering when starting and requires less power when drilling.

Viper Plus Drills
Industrial quality drill bit designed for machine and hand held drilling in stainless steel, aluminium, cast iron, brass, wood and plastic.

INOX Drills
Industrial quality drilling solution specially designed for superior performance in stainless steel.

Heavy Duty Cobalt
Industrial quality drill bit for drilling materials that have high hardness and tensile strength such as cast iron, bronze, hard steel and stainless steel.

TiNite Drills*
Lasts up to 6 times longer than standard HSS drill bits.

Description	Drill Sizes	Case	Pieces	Item #	Barcode
Silver Bullet Drill Sets (A1202)				D101	
SM1	1.5mm – 6.5mm x 0.5mm + 3.2mm, 4.8mm	Plastic	13	D101 SM1	9311963001661
SM2	1.0 – 10.0mm x 0.5	ABS	19	D101 SM2	9311963001258
SM3	1.0 – 13.0mm x 0.5	ABS	25	D101 SM3	9311963000718
MTLSM2	1.0 – 10.0mm x 0.5	Metal	19	D101 MTL SM2	9311963601199
MTLSM3	1.0 – 13.0mm x 0.5	Metal	25	D101 MTL SM3	9311963601205
Silver Bullet Refill Kits (A1202)					
SRKM2	1.5mm – 3.5mm x 0.5mm	Tray	5	D101 SRKM2	9311963191492
SRKM3	1.5, 2.0, 3.0, 4.0, 5.0mm	Tray	5	D101 SRKM3	9311963191508
SRK20	Merchandise 5 each: SRK2, SRK3, SRKM2, SRKM3		20	D101 SRK20	9311963359595
Drill Stands (Z0204)					
SM7	1.0 – 3.0mm x 0.25, 3.5 – 13.0mm x 0.5	Metal	1	D101 SM7	9311963004334
Blue Bullet Drill Sets (A1202)				D102	
SM1	1.5mm – 6.5mm x 0.5mm + 3.2mm, 4.8mm	Plastic	13	D102 SM1	9311963047034
SM2	1.0 – 10.0mm x 0.5	ABS	19	D102 SM2	9311963047041
SM3	1.0 – 13.0mm x 0.5	ABS	25	D102 SM3	9311963047058
SM8	1.0 – 3.0mm x 0.25, 3.5 – 13.0mm x 0.5 (Suits SM7 Stand)	Quad Pack	29	D102 SM8	9311963098289
SM30	1.0mm – 5.9mm x 0.1	Metal	50	D102 SM30	9311963006987
SM41	6.0mm – 10.0mm x 0.1	Metal	41	D102 SM41	9311963034973
SM99	1.0 – 10.0mm x 0.1 (Plus 10.5, 10.9, 11.0, 11.5, 11.9, 12.0, 12.5, 12.9, 13.0mm)	Plastic	100	D102 SM99	9311963334738
SM101	1.0 – 10.0mm x 0.5 (Plus BONUS 25ml Venom Cutting Paste)	Plastic	101	D102 SM101	9311963622026
Viper Drill Sets (A1202)				D105	
SLV7M	1.5, 2.0, 3.0, 4.0, 5.0, 5.5, 6.0mm	Plastic	7	D105 SLV7M	9311963375045
SLV10M	1.0mm – 10.0mm x 1.0mm	Plastic	10	D105 SLV10M	9311963375052
SLV13M	1.5mm – 6.5mm x 0.5mm + 3.2mm, 4.8mm	Plastic	13	D105 SLV13M	9311963375069
V2M	1.0mm – 10.0mm x 0.5mm	ABS	19	D105 V2M	9311963374994
V3M	1.0mm – 13.0mm x 0.5mm (10.5-13.0mm x 10.0mm Shanks)	ABS	25	D105 V3M	9311963358215
Viper Plus Drill Sets (A1202)				D179	
SM2	1.0 – 10.0mm x 0.5	ABS	19	D179 SM2	9311963586182
SM3	1.0 – 13.0mm x 0.5	ABS	25	D179 SM3	9311963586199
INOX Drill Sets (A1202)				D180	
SM2	1.0 – 10.0mm x 0.5	ABS	19	D180 SM2	9311963512693
SM3	1.0 – 13.0mm x 0.5	ABS	25	D180 SM3	9311963512709
Heavy Duty Cobalt Drill Sets (A0404)				D109	
SM2	1.0 – 10.0mm x 0.5	ABS	19	D109 SM2	9311963122021
SM3	1.0 – 13.0mm x 0.5	ABS	25	D109 SM3	9311963122038
TiNite Drill Set (A1216)				D103	
SM3	1.0 – 13.0mm x 0.5	ABS	25	D103 SM3	9311963071435

*New case not applied.

suttontools

Section Index



D101 S2



D101 S3



D101 MTL52



D101 MTL53



D101 S30



D101 S31



D101 SRK1



D101 SRK2



D101 SRK3



D101 SRK20



D101 S7



D102 S2



D102 S3



D102 S8



D105 SLV7



D105 SLV10



D105 SLV11



D105 SLV13



D105 V2



D105 V3



D179 S2



D179 S3



D109 S2



D109 S3



D103 S3



suttontools



Silver Bullet Drills

General purpose drill bit designed for machine and hand held drilling in a wide range of ferrous and non-ferrous materials.

Blue Bullet Drills

The blue finish reduces chip build up on the cutting edge and is a better choice when drilling ferrous materials.

Viper Drills

The Viper bit point design is 118° split point is self-centring. It minimises wandering when starting and requires less power when drilling.

Viper Plus Drills

Industrial quality drill bit designed for machine and hand held drilling in stainless steel, steel, aluminium, cast iron, brass, wood and plastic.

Heavy Duty Cobalt

Industrial quality drill bit for drilling materials that have high hardness and tensile strength such as cast iron, bronze, hard steel and stainless steel.

TiNite Drills*

Lasts up to 6 times longer than standard HSS drill bits.

Description	Drill Sizes	Case	Pieces	Item #	Barcode
Silver Bullet Drill Sets (A1202)					
S2	1/16 – 3/8 x 64ths	ABS	21	D101 S2	9311963000343
S3	1/16 – 1/2 x 64ths	ABS	29	D101 S3	9311963000060
MTLS2	1/16 – 3/8 x 64ths	Metal	21	D101 MTLS2	9311963601168
MTLS3	1/16 – 1/2 x 64ths	Metal	29	D101 MTLS3	9311963601175
S30	#1 – #60 Wire Gauge	Metal	60	D101 S30	9311963006079
S31	#61 – #80 Wire Gauge	Plastic	20	D101 S31	9311963007847
Silver Bullet Refill Kits (A1202)					
SRK1	1/16, 3/32, 1/8	Tray	3	D101 SRK1	9311963046914
SRK2	1/16 – 1/8 x 1/64ths	Tray	5	D101 SRK2	9311963046921
SRK3	1/16 – 3/16 x 1/32nds	Tray	5	D101 SRK3	9311963046938
SRK20	Merchandise 5 each: SRK2, SRK3, SRKM2, SRKM3		20	D101 SRK20	9311963359595
Drill Stands (Z0204)					
S7	1/16 – 1/2 x 64ths	Metal	1	D101 S7	9311963003610
Blue Bullet Drill Sets (A1202)					
S2	1/16 – 3/8 x 64ths	ABS	21	D102 S2	9311963034997
S3	1/16 – 1/2 x 64ths	ABS	29	D102 S3	9311963028828
S8	1/16 – 1/2 x 64ths (Suits S7 Stand)	Quad Pack	29	D102 S8	9311963046990
Viper Drill Sets (A1202)					
SLV7	1/16 – 1/4 x 1/32	Plastic	7	D105 SLV7	9311963375007
SLV10	1/16 – 5/32 x 1/64 + 3/16, 7/32, 1/4	Plastic	10	D105 SLV10	9311963375014
SLV11	1/16 – 3/8 x 1/32	Plastic	11	D105 SLV11	9311963375021
SLV13	1/16 – 1/4 x 1/64	Plastic	13	D105 SLV13	9311963375038
V2	1/16 – 3/8 x 1/64	ABS	21	D105 V2	9311963374987
V3	1/16 – 1/2 x 1/64 (25/64 – 1/2 x 3/8 Shanks)	ABS	29	D105 V3	9311963358208
Viper Plus Drill Sets (A1202)					
S2	1/16 – 3/8 x 64ths	ABS	21	D179 S2	9311963586175
S3	1/16 – 1/2 x 64ths	ABS	29	D179 S3	9311963579740
Heavy Duty Cobalt Drill Sets (A0404)					
S2	1/16 – 3/8 x 64ths	ABS	21	D109 S2	9311963100265
S3	1/16 – 1/2 x 64ths	ABS	29	D109 S3	9311963100272
TiNite Drill Set (A1216)					
S3	1/16 – 1/2 x 64ths	ABS	29	D103 S3	9311963067261

*New case not applied.



Section Index



166044639



166044641



166044642



166044635



166044637



166044638



165399200^



149060015^



149060016^



149060004^



149060005^



149060006^



150BOW513^



150BOW52M^



150BOW53M^

^New look packaging depicted. Actual product packaging may differ from image shown.



High Speed Steel

General purpose drill bit designed for machine and hand held drilling in metal, wood and plastic.

Discount Group: A1202

Description	Drill Sizes	Case	Pieces	Item #	Barcode
HSS Drill Sets - Metric					
M1	1.5 – 6.5mm x 0.5mm rises plus 3.3 & 4.2mm	Plastic	13	166044639	9311744446391
M2	1.0 – 10mm x 0.5mm rises	Plastic	19	166044641	9311744446414
M3	1.0 – 13mm x 0.5mm rises	Plastic	25	166044642	9311744446421
HSS Drill Sets - Imperial					
F1	1/16 – 1/4" x 1/64" rise	Plastic	13	166044635	9311744446353
F2	1/16 – 3/8" x 1/64" rises	Plastic	21	166044637	9311744446377
F3	1/16 – 1/2" x 1/64" rises	Plastic	29	166044638	9311744446384
HSS Bright Drill Set - Metric & Imperial^					
200	Metric Sizes: 1.0 – 6.0 x 0.5mm rises + 3.2, 4.2, 8.0, 10.0, 12.0mm Imperial Sizes: 5/64 – 7/32 x 1/64" rises + 1/4, 5/16, 3/8, 1/2"	Plastic	200	165399200	9311744446049
HSS Drill Set + BONUS Step Drill^					
0015	Bright: 2.0–10mm x 0.5mm rises + 3.3, 4.2, 6.8mm Step Drill: 9 Steps 4, 6, 8, 10, 12, 14, 16, 18, 20mm	Plastic	19	149060015	9311744446063
0016	Cobalt: 2.0–10mm x 0.5mm rises + 3.3, 4.2, 6.8mm Step Drill: 9 Steps 4, 6, 8, 10, 12, 14, 16, 18, 20mm	Plastic	19	149060016	9311744446117
HSS Drill Set + BONUS Countersink^					
0004	Bright: 2.0–13.0 x 0.5mm rises +16.5mm Countersink	Plastic	25	149060004	9311744445813
0005	Blue: 2.0–13.0 x 0.5mm rises +16.5mm Countersink	Plastic	25	149060005	9311744445820
0006	Cobalt: 2.0–13.0 x 0.5mm rises +16.5mm Countersink	Plastic	25	149060006	9311744445837



Titanium Nitride (TiN) Coated Tip

For increased wear resistance delivering 3X longer life. The highest wear is incurred at the drill tip and cutting edges to depths twice the drill diameter.

Discount Group: A1202

Description	Drill Sizes	Case	Pieces	Item #	Barcode
HSS TiN Coated Tip Drill Sets^					
WS13	1.5 – 6.5mm x 0.5mm + 3.3 & 4.2mm	Plastic	13	150B0WS13	9311744442010
WS2M	1.0–10.0 x 0.5mm rises	Plastic	19	150B0WS2M	9311744439089
WS3M	1.0–13.0 x 0.5mm rises	Plastic	25	150B0WS3M	9311744439096

^New look packaging depicted. Actual product packaging may differ from image shown.

Drills Jobber Bulk Pack – Silver Bullet

suttontools



General purpose drill bit designed for machine and hand held drilling in a wide range of ferrous and non-ferrous materials.

118° Standard Point
Common point for general purpose applications

Parallel Shank
Precision engineering for accurate hole size

Made from European HSS
Constructed from M2 High Speed Steel offering the best combination of strength, heat and wear resistance

Application

- DIY
- Trade
- Automotive
- Electrical
- Plumbing
- Carpentry
- General Contracting
- Woodworking
- Metalworking
- Machine Shop
- MRO



Quad Pack



Hang Pack

Discount Group: A0402

Diameter mm	O/A Length	Flute Length	Pack Qty	Item #	Barcode
Metric - Quad Pack				D101	
0.5	22	6	10	D101 0050	9311963007250
1.0	34	12	10	D101 0100	9311963001487
1.5	40	18	10	D101 0150	9311963001999
2.0	49	24	10	D101 0200	9311963001364
2.5	57	30	10	D101 0250	9311963001210
3.0	61	33	10	D101 0300	9311963001159
3.3	65	36	10	D101 0330	9311963001784
3.5	70	39	10	D101 0350	9311963001326
4.0	75	43	10	D101 0400	9311963000732
4.2	75	43	10	D101 0420	9311963002026
4.5	80	47	10	D101 0450	9311963002309
5.0	86	52	10	D101 0500	9311963000480
5.5	93	57	10	D101 0550	9311963002927
6.0	93	57	10	D101 0600	9311963000886
6.5	101	63	10	D101 0650	9311963001562
6.8	109	69	10	D101 0680	9311963002767
7.0	109	69	10	D101 0700	9311963001739
7.5	109	69	10	D101 0750	9311963003528
8.0	117	75	5	D101 0800	9311963001494
8.2	117	75	5	D101 0820	9311963006710
8.4	117	75	5	D101 0840	9311963007182
8.5	117	75	5	D101 0850	9311963002484
9.0	125	81	5	D101 0900	9311963002934
9.5	125	81	5	D101 0950	9311963003085
10.0	133	87	5	D101 1000	9311963001043
10.2	133	87	5	D101 1020	9311963004396
10.5	133	87	5	D101 1050	9311963001920
10.8	142	94	5	D101 1080	9311963010175
11.0	142	94	5	D101 1100	9311963002194
11.5	142	94	5	D101 1150	9311963002866
12.0	151	101	5	D101 1200	9311963001654
12.5	151	101	5	D101 1250	9311963002941
13.0	151	101	5	D101 1300	9311963002415

Diameter mm	O/A Length	Flute Length	Pack Qty	Item #	Barcode
Metric - Hang Pack				D104	
1.5	40	18	10	D104 0150	9311963551869
2.0	49	24	10	D104 0200	9311963141565
2.5	57	30	10	D104 0250	9311963551876
3.0	61	33	10	D104 0300	9311963141572
3.5	70	39	10	D104 0350	9311963551883
4.0	75	43	10	D104 0400	9311963141596
5.0	86	52	5	D104 0500	9311963141862
6.0	93	57	5	D104 0600	9311963141879
6.5	101	63	5	D104 0650	9311963551890



Merchandise

Metric Bulk Drill Bits, 405 Pce - item # 499999836 (case only)
 20 each: 1.0, 1.5, 2.0, 2.5, 3.0, 3.3, 3.5, 4.0, 4.2, 4.5, 5.0, 5.5, 6.0, 6.5, 6.8mm
 10 each: 7.0, 7.5, 8.0, 10.0mm
 5 each: 8.2, 8.4, 8.5, 9.0, 9.5, 10.2, 10.5, 10.8, 11.0, 11.5, 12.0, 12.5, 13mm

Drills Jobber Bulk Pack – Silver Bullet

suttontools



General purpose drill bit designed for machine and hand held drilling in a wide range of ferrous and non-ferrous materials.

118° Standard Point
Common point for general purpose applications



Quad Pack



Hang Pack

Parallel Shank
Precision engineering for accurate hole size

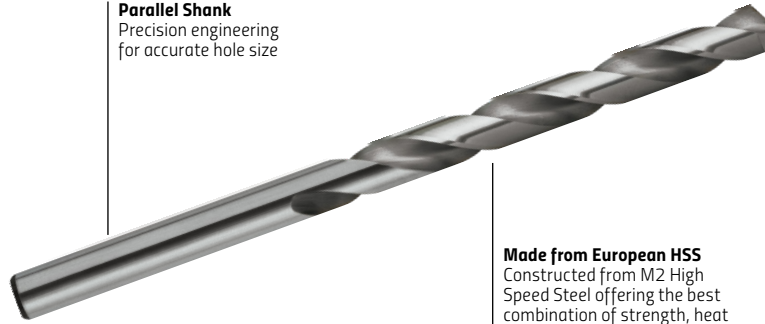

Made from European HSS
Constructed from M2 High Speed Steel offering the best combination of strength, heat and wear resistance

Application

- DIY
- Trade
- Automotive
- Electrical
- Plumbing
- Carpentry
- General Contracting
- Woodworking
- Metalworking
- Machine Shop
- MRO

Section Index

Discount Group: A0402

Diameter inch	O/A mm	Flute Length	Pack Qty	Item #	Barcode
Imperial - Quad Pack				D101	
1/64	0.40	19	5	D101 0039	9311963005317
1/32	0.79	35	13	D101 0079	9311963002460
3/64	1.19	44	19	D101 0119	9311963002477
1/16	1.59	48	22	D101 0159	9311963000411
5/64	1.98	51	25	D101 0198	9311963000473
3/32	2.38	57	32	D101 0238	9311963000138
7/64	2.78	67	38	D101 0278	9311963000190
1/8	3.18	70	41	D101 0318	9311963000022
9/64	3.57	73	44	D101 0357	9311963000152
5/32	3.97	79	51	D101 0397	9311963000084
11/64	4.37	83	54	D101 0437	9311963000336
3/16	4.76	89	59	D101 0476	9311963000046
13/64	5.16	92	62	D101 0516	9311963000244
7/32	5.56	95	64	D101 0556	9311963000435
15/64	5.95	98	67	D101 0595	9311963000862
1/4	6.35	102	70	D101 0635	9311963000039
17/64	6.75	105	73	D101 0676	9311963000602
9/32	7.14	108	75	D101 0714	9311963000695
19/64	7.54	111	78	D101 0754	9311963002156
5/16	7.94	114	81	D101 0794	9311963000305
21/64	8.33	117	84	D101 0833	9311963001524
11/32	8.73	121	87	D101 0873	9311963000954
23/64	9.13	124	89	D101 0913	9311963001616
3/8	9.52	127	92	D101 0953	9311963000121
25/64	9.92	130	95	D101 0992	9311963001203
13/32	10.32	133	98	D101 1032	9311963000756
27/64	10.72	137	100	D101 1072	9311963001982
7/16	11.11	140	103	D101 1111	9311963000664
29/64	11.51	143	106	D101 1151	9311963002101
15/32	11.91	146	110	D101 1191	9311963001432
31/64	12.30	149	111	D101 1231	9311963001869
1/2	12.70	152	114	D101 1269	9311963000206

Diameter inch	O/A mm	Flute Length	Pack Qty	Item #	Barcode
Imperial - Hang Pack				D104	
1/16	1.59	48	22	D104 0159	9311963339030
5/64	1.98	51	25	D104 0198	9311963339047
3/32	2.38	57	32	D104 0238	9311963339054
7/64	2.78	67	38	D104 0278	9311963339061
1/8	3.18	70	41	D104 0318	9311963339078
9/64	3.57	73	44	D104 0357	9311963339085
5/32	3.97	79	51	D104 0397	9311963339092
3/16	4.76	89	59	D104 0476	9311963339115
1/4	6.35	101	63	D104 0635	9311963339153



Merchandiser
Imperial Bulk Drill Bits, 375 Pce - item # 499999836 (case only)
 20 each: 1/16, 5/64, 3/32, 7/64, 1/8, 9/64, 5/32, 11/64, 3/16, 13/64, 7/32, 15/64, 1/4, 17/64
 10 each: 9/32, 19/64, 5/16, 3/8
 5 each: 21/64, 11/32, 23/64, 25/64, 13/32, 27/64, 7/16, 29/64, 15/32, 31/64, 1/2

Drills Jobber – Blue Bullet

suttontools



General purpose drill bit designed for machine and hand held drilling in ferrous metals, wood and plastic.

118° Standard Point
Common point for general purpose applications

Made from European High Speed Steel

Parallel Shank
Precision engineered for accurate hole size

Blue finish
Reduces chip build up on the cutting edge

Application

- DIY
- Trade
- Automotive
- Electrical
- Plumbing
- Carpentry
- General Contracting
- Woodworking
- Metalworking
- Machine Shop
- MRO



Discount Group: A0410

Diameter mm	O/A Length	Flute Length	Item #	Barcode
Metric	mm	mm	D129	
1.0	34	12	D129 0100	9311963626376
1.5	40	18	D129 0150	9311963626383
2.0	49	24	D129 0200	9311963626390
2.5	57	30	D129 0250	9311963626406
3.0	61	33	D129 0300	9311963626413
3.3	65	36	D129 0330	9311963626642
3.5	70	39	D129 0350	9311963626420
4.0	75	43	D129 0400	9311963626437
4.2	75	43	D129 0420	9311963626659
4.5	80	47	D129 0450	9311963626444
5.0	86	52	D129 0500	9311963626451
5.5	93	57	D129 0550	9311963626468
6.0	93	57	D129 0600	9311963626475
6.5	101	63	D129 0650	9311963626482
6.8	109	69	D129 0680	9311963626666
7.0	109	69	D129 0700	9311963626499
7.5	109	69	D129 0750	9311963626505
8.0	117	75	D129 0800	9311963626512
8.5	117	75	D129 0850	9311963626529
9.0	125	81	D129 0900	9311963626536
9.5	125	81	D129 0950	9311963626543
10.0	133	87	D129 1000	9311963626550
10.2	133	87	D129 1020	9311963626673
10.5	133	87	D129 1050	9311963626567
11.0	142	94	D129 1100	9311963626574
11.5	142	94	D129 1150	9311963626581
12.0	151	101	D129 1200	9311963626598
12.5	151	101	D129 1250	9311963626604
13.0	151	101	D129 1300	9311963626611

Diameter inch	Diameter mm	O/A Length	Flute Length	Item #	Barcode
Imperial	mm	mm	D129		
1/16	1.59	48	22	D129 0159	9311963626086
5/64	1.98	51	25	D129 0198	9311963626093
3/32	2.38	57	32	D129 0238	9311963626109
7/64	2.78	67	38	D129 0278	9311963626116
1/8	3.18	70	41	D129 0318	9311963626123
9/64	3.57	73	44	D129 0357	9311963626130
5/32	3.97	79	51	D129 0397	9311963626147
11/64	4.37	83	54	D129 0437	9311963626154
3/16	4.76	89	59	D129 0476	9311963626161
13/64	5.16	92	62	D129 0516	9311963626178
7/32	5.56	95	64	D129 0556	9311963626185
15/64	5.95	98	67	D129 0595	9311963626192
1/4	6.35	101	63	D129 0635	9311963626208
17/64	6.75	105	73	D129 0676	9311963626215
9/32	7.14	108	75	D129 0714	9311963626222
19/64	7.54	111	78	D129 0754	9311963626239
5/16	7.94	114	81	D129 0794	9311963626246
21/64	8.33	117	84	D129 0833	9311963626253
11/32	8.73	121	87	D129 0873	9311963626260
23/64	9.13	124	89	D129 0913	9311963626277
3/8	9.52	127	92	D129 0953	9311963626284
25/64	9.92	130	95	D129 0992	9311963626291
13/32	10.32	133	98	D129 1032	9311963626307
27/64	10.72	137	100	D129 1072	9311963626314
7/16	11.11	140	103	D129 1111	9311963626321
29/64	11.51	143	106	D129 1151	9311963626338
15/32	11.91	146	110	D129 1191	9311963626345
31/64	12.30	151	111	D129 1231	9311963626352
1/2	12.70	152	114	D129 1269	9311963626369



General purpose drill bit designed for machine and hand held drilling in a wide range of ferrous and non-ferrous materials.



Reduced Shank
Drill sizes above 10mm and 3/8" feature reduced shanks to suit 10mm drill chucks

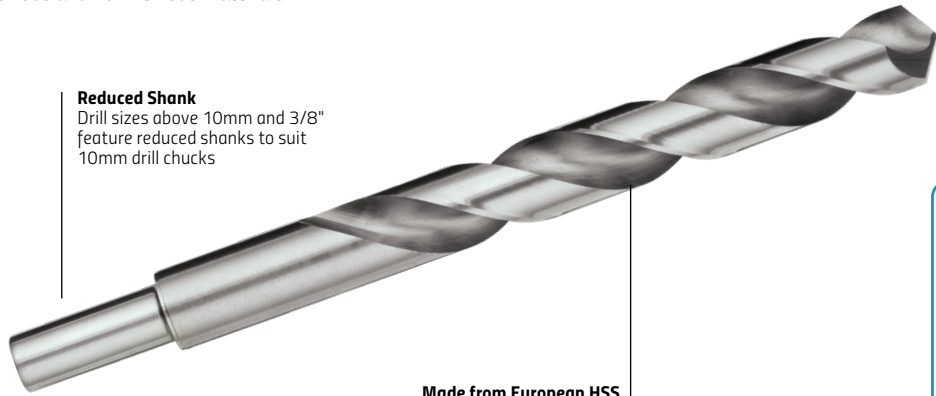

Made from European HSS
Stronger and out performs a conventional drill bit

118° Split Point
Drills >3.5mm and 9/64"
Minimises wandering when starting

Application

- DIY
- Trade
- Automotive
- Electrical
- Plumbing
- Carpentry
- General Contracting
- Woodworking
- Metalworking
- Machine Shop
- MRO



Discount Group: A0410

Diameter mm	O/A Length	Flute Length	Shank mm	Item #	Barcode
Metric	mm	mm		D105	
1.0	34	12		D105 0100	93221153
1.5	40	18		D105 0150	93221160
2.0	49	24		D105 0200	93221177
2.5	57	30		D105 0250	93221184
3.0	61	33		D105 0300	93221191
3.5	70	39		D105 0350	93221207
4.0	75	43		D105 0400	93221214
4.5	80	47		D105 0450	93221221
5.0	86	52		D105 0500	93221238
5.5	93	57		D105 0550	93221245
6.0	93	57		D105 0600	93221252
6.5	101	63		D105 0650	93221269
7.0	109	69		D105 0700	93221276
7.5	109	69		D105 0750	93221283
8.0	117	75		D105 0800	93221290
8.5	117	75		D105 0850	93221306
9.0	125	81		D105 0900	93221313
9.5	125	81		D105 0950	93221320
10.0	133	87		D105 1000	93220637
10.5†	133	87	10	D105 1050	93220644
11.0†	142	94	10	D105 1100	93220651
11.5†	142	94	10	D105 1150	93220668
12.0†	151	101	10	D105 1200	93220675
12.5†	151	101	10	D105 1250	93220682
13.0†	151	101	10	D105 1300	93220699

Diameter inch	O/A Length mm	Flute Length mm	Shank Inch	Item #	Barcode
Imperial	mm	mm		D105	
1/16	1.59	48	22	D105 0159	93220545
5/64	1.98	51	25	D105 0198	93220552
3/32	2.38	57	32	D105 0238	93220569
7/64	2.78	67	38	D105 0278	93220576
1/8	3.18	70	41	D105 0318	93220583
9/64	3.57	73	44	D105 0357	93220590
5/32	3.97	79	51	D105 0397	93220606
11/64	4.37	83	54	D105 0437	93220613
3/16	4.76	89	59	D105 0476	93220620
13/64	5.16	92	62	D105 0516	93220958
7/32	5.56	95	64	D105 0556	93220965
15/64	5.95	98	67	D105 0595	93220972
1/4	6.35	101	63	D105 0635	93220989
17/64	6.75	105	73	D105 0676	93220996
9/32	7.14	108	75	D105 0714	93221009
19/64	7.54	111	78	D105 0754	93221016
5/16	7.94	114	81	D105 0794	93221023
21/64	8.33	117	84	D105 0833	93221030
11/32	8.73	121	87	D105 0873	93221047
23/64	9.13	124	89	D105 0913	93221054
3/8	9.52	127	92	D105 0953	93221061
25/64†	9.92	130	95	D105 0992	93221078
13/32†	10.32	133	98	D105 1032	93221085
27/64†	10.72	137	100	D105 1072	93221092
7/16†	11.11	140	103	D105 1111	93221108
29/64†	11.51	143	106	D105 1151	93221115
15/32†	11.91	146	110	D105 1191	93221122
31/64†	12.30	151	111	D105 1231	93221139
1/2†	12.70	152	114	D105 1269	93221146

† Viper Bits have 10mm (3/8") reduced shank for sizes > 10mm (3/8").

Drills Jobber – Viper Plus



Industrial quality drill designed for machine and hand held drilling in stainless steel, steel, aluminium, cast iron, brass, wood and plastic.

Featuring a Futura Nano PVD coated tip – the latest generation coating for ultimate wear resistance and increased productivity.

Futura Nano PVD Coated Tip
For ultimate wear resistance



Check out the demo

118° Split Point
Drills >3.5mm and 9/64"
Minimises wandering when starting

Made from European HSS
Stronger and out performs a conventional drill bit

2X Greater Tool Life
Independently tested for longer life compared to regular drill bit

Application

- DIY
- Trade
- Automotive
- Electrical
- Plumbing
- Carpentry
- General Contracting
- Woodworking
- Metalworking
- Machine Shop
- MRO

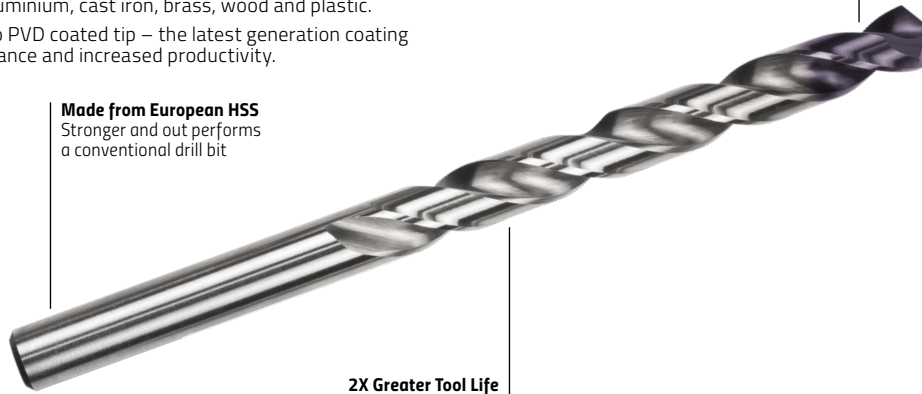

Discount Group: A0410

Diameter mm	O/A Length	Flute Length	Item #	Barcode
Metric	mm	mm	D184	
1.0	34	12	D184 0100	9311963600444
1.5	40	18	D184 0150	9311963600451
2.0	49	24	D184 0200	9311963600468
2.5	57	30	D184 0250	9311963600475
3.0	61	33	D184 0300	9311963600482
3.3	65	36	D184 0330	9311963601946
3.5	70	39	D184 0350	9311963600499
4.0	75	43	D184 0400	9311963600505
4.2	75	43	D184 0420	9311963601953
4.5	80	47	D184 0450	9311963600512
5.0	86	52	D184 0500	9311963600529
5.5	93	57	D184 0550	9311963600536
6.0	93	57	D184 0600	9311963600543
6.5	101	63	D184 0650	9311963600550
6.8	109	69	D184 0680	9311963601960
7.0	109	69	D184 0700	9311963600567
7.5	109	69	D184 0750	9311963600574
8.0	117	75	D184 0800	9311963600581
8.5	117	75	D184 0850	9311963600598
9.0	125	81	D184 0900	9311963600604
9.5	125	81	D184 0950	9311963600611
10.0	133	87	D184 1000	9311963600628
10.2	133	87	D184 1020	9311963601977
10.5	133	87	D184 1050	9311963600635
11.0	142	94	D184 1100	9311963600642
11.5	142	94	D184 1150	9311963600659
12.0	151	101	D184 1200	9311963600666
12.5	151	101	D184 1250	9311963600673
13.0	151	101	D184 1300	9311963600680

Sutton Tools INOX jobber drills are an industrial quality drilling solution specially designed for superior performance in stainless steel.

Tailored to overcome the difficult-to-machine material properties of stainless steel, INOX drill bits have a fast spiral, short flute and unique stepped core design providing a smooth and effortless cutting action never before seen.



Check out the demo



70%
MORE LIFE*

Specialised design
Achieves 70% more life *in stainless steel than standard drill bits

Made from European High Speed Steel

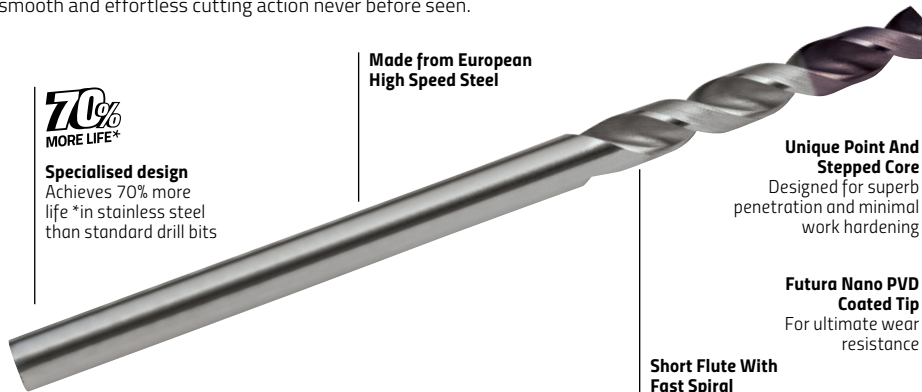

Unique Point And Stepped Core
Designed for superb penetration and minimal work hardening

Futura Nano PVD Coated Tip
For ultimate wear resistance

Short Flute With Fast Spiral
For maximum rigidity and swarf control

Application

- DIY
- Trade
- Automotive
- Electrical
- Plumbing
- Carpentry
- General Contracting
- Woodworking
- Metalworking
- Machine Shop
- MRO

Discount Group: A0410

Diameter mm	O/A Length	Flute Length	Item #	Barcode
Metric	mm	mm	D185	
1.0	34	8	D185 0100	9311963601984
1.5	40	11	D185 0150	9311963601991
2.0	49	14	D185 0200	9311963602004
2.5	57	16	D185 0250	9311963602011
3.0	61	18	D185 0300	9311963602028
3.3	65	20	D185 0330	9311963602035
3.5	70	22	D185 0350	9311963602042
4.0	75	25	D185 0400	9311963602059
4.2	75	25	D185 0420	9311963602066
4.5	80	28	D185 0450	9311963602073
5.0	86	32	D185 0500	9311963602080
5.5	93	36	D185 0550	9311963602097
6.0	93	36	D185 0600	9311963602103
6.5	101	40	D185 0650	9311963602110
6.8	109	45	D185 0680	9311963602127
7.0	109	45	D185 0700	9311963602134
7.5	109	45	D185 0750	9311963602141
8.0	117	51	D185 0800	9311963602158
8.5	117	51	D185 0850	9311963602165
9.0	125	57	D185 0900	9311963602172
9.5	125	57	D185 0950	9311963602189
10.0	133	63	D185 1000	9311963602196
10.2	133	63	D185 1020	9311963602202
10.5	133	63	D185 1050	9311963602219
11.0	142	71	D185 1100	9311963602226
11.5	142	71	D185 1150	9311963602233
12.0	151	78	D185 1200	9311963602240
12.5	151	78	D185 1250	9311963602257
13.0	151	78	D185 1300	9311963602264

suttontools

Industrial quality for drilling materials that have high hardness and tensile strength such as cast iron, bronze, hardened steel and stainless steel.



Cobalt Alloyed
The 5% cobalt formula improves abrasive and heat resistance, for increased strength at higher drilling temperatures

Thick Core
For increased rigidity in hard materials

135° Split Point
Drills > 2mm and 3/32
Enables accurate positioning and less drilling pressure

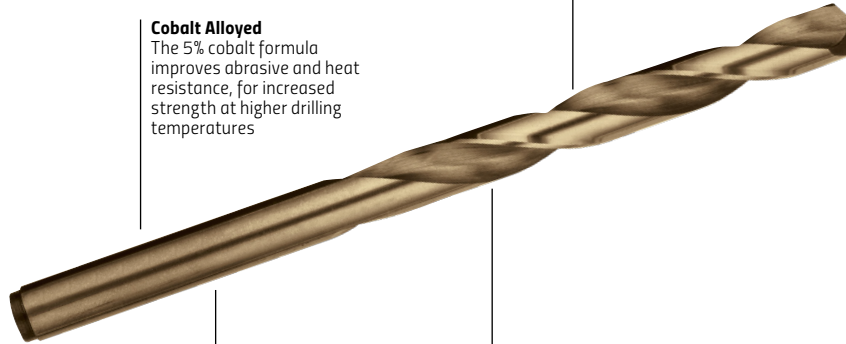

Made from European High Speed Steel

Surface Finish
Colour tempered finish enables identification of cobalt drills

Application

- DIY
- Trade
- Automotive
- Electrical
- Plumbing
- Carpentry
- General Contracting
- Woodworking
- Metalworking
- Machine Shop
- MRO

Discount Group: A0404

Diameter mm	O/A Length	Flute Length	Item #	Barcode
Metric	mm	mm	D108	
1.0	34	12	D108 0100	9311963181059
1.5	40	18	D108 0150	9311963181103
2.0	49	24	D108 0200	9311963100128
2.5	57	30	D108 0250	9311963100180
3.0	61	33	D108 0300	9311963093574
3.5	70	39	D108 0350	9311963093611
4.0	75	43	D108 0400	9311963093642
4.5	80	47	D108 0450	9311963093680
5.0	86	52	D108 0500	9311963093703
5.5	93	57	D108 0550	9311963093734
6.0	93	57	D108 0600	9311963093741
6.5	101	63	D108 0650	9311963093758
7.0	109	69	D108 0700	9311963093796
7.5	109	69	D108 0750	9311963093802
8.0	117	75	D108 0800	9311963093925
8.5	117	75	D108 0850	9311963093963
9.0	125	81	D108 0900	9311963093987
9.5	125	81	D108 0950	9311963094014
10.0	133	87	D108 1000	9311963094038
10.5	133	87	D108 1050	9311963094052
11.0	142	94	D108 1100	9311963094076
11.5	142	94	D108 1150	9311963094083
12.0	151	101	D108 1200	9311963094106
12.5	151	101	D108 1250	9311963094120
13.0	151	101	D108 1300	9311963094151

Diameter inch	Diameter mm	O/A Length	Flute Length	Item #	Barcode
Imperial	mm	mm	mm	D108	
1/16	1.59	48	22	D108 0159	9311963020068
5/64	1.98	51	25	D108 0198	9311963035529
3/32	2.38	57	32	D108 0238	9311963026855
7/64	2.78	67	38	D108 0278	9311963026862
1/8	3.18	70	41	D108 0318	9311963093321
9/64	3.57	73	44	D108 0357	9311963093338
5/32	3.97	79	51	D108 0397	9311963093345
11/64	4.37	83	54	D108 0437	9311963093352
3/16	4.76	89	59	D108 0476	9311963093369
13/64	5.16	92	62	D108 0516	9311963093376
7/32	5.56	95	64	D108 0556	9311963093383
15/64	5.95	98	67	D108 0595	9311963093390
1/4	6.35	101	63	D108 0635	9311963093406
17/64	6.75	105	73	D108 0676	9311963093413
9/32	7.14	108	75	D108 0714	9311963093420
19/64	7.54	111	78	D108 0754	9311963093437
5/16	7.94	114	81	D108 0794	9311963093444
21/64	8.33	117	84	D108 0833	9311963093451
11/32	8.73	121	87	D108 0873	9311963093468
23/64	9.13	124	89	D108 0913	9311963093475
3/8	9.52	127	92	D108 0953	9311963093482
25/64	9.92	130	95	D108 0992	9311963093499
13/32	10.32	133	98	D108 1032	9311963093505
27/64	10.72	137	100	D108 1072	9311963093512
7/16	11.11	140	103	D108 1111	9311963093529
29/64	11.51	143	106	D108 1151	9311963093536
15/32	11.91	146	110	D108 1191	9311963093543
31/64	12.30	151	111	D108 1231	9311963093550
1/2	12.70	152	114	D108 1269	9311963093567

Drills Jobber – Left Hand Cobalt

suttontools

Left-Hand jobber drills feature a left hand helix for screw machine applications where spindles rotate counter-clockwise. Suitable for general-purpose drilling and can also be used to drill out broken bolts in conjunction with Sutton Tools screw extractors.

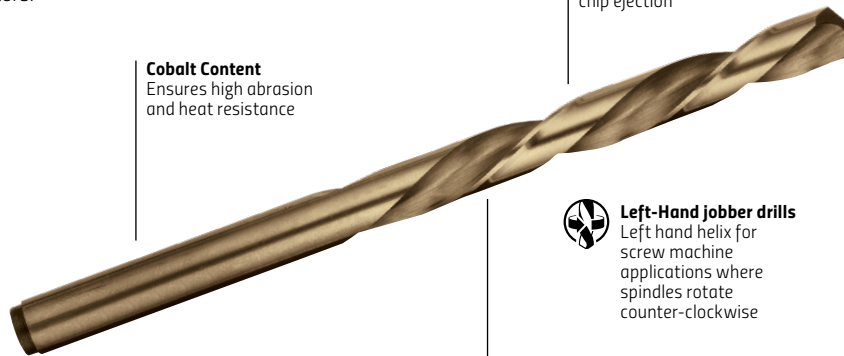

Cobalt Content
Ensures high abrasion and heat resistance

Spiral Flute
Heavy duty spiral flute design produces faster chip ejection

118° Standard Point
Common point for general purpose applications



Left-Hand jobber drills
Left hand helix for screw machine applications where spindles rotate counter-clockwise

Length
Shorter drilling length designed for rigidity

Application

- DIY
- Trade
- Automotive
- Electrical
- Plumbing
- Carpentry
- General Contracting
- Woodworking
- Metalworking
- Machine Shop
- MRO

Discount Group: A0404

Diameter mm	O/A Length	Flute Length	Extractor Size	Pieces	Item #	Barcode
Metric	mm	mm				D202
1.0	34	12		1	D202 0100	9311963607658
2.0	49	24	#1	1	D202 0200	9311963602851
3.0	61	33	#2	1	D202 0300	9311963602868
4.0	75	43	#3	1	D202 0400	9311963602875
5.0	86	52		1	D202 0500	9311963607702
5.5	93	57	#4	1	D202 0550	9311963602882
6.0	93	57		1	D202 0600	9311963607719
7.0	109	69		1	D202 0700	9311963607733
7.5	109	69	#5	1	D202 0750	9311963602899
8.0	117	75		1	D202 0800	9311963607740
9.0	125	81		1	D202 0900	9311963607764
10.0	133	87		1	D202 1000	9311963607788
11.0	142	94		1	D202 1100	9311963607801
12.0	151	101		1	D202 1200	9311963607818
13.0	151	101		1	D202 1300	9311963607825
Set						
1.0 - 10mm x 1.0mm rises				10	D202 LH10M	9311963622002



D202 LH10M

Drills Jobber – TiN



Titanium Nitride (TiN) Coated Tip for increased wear resistance delivering 3X longer life. The highest wear is incurred at the drill tip and cutting edges to depths twice the drill diameter.

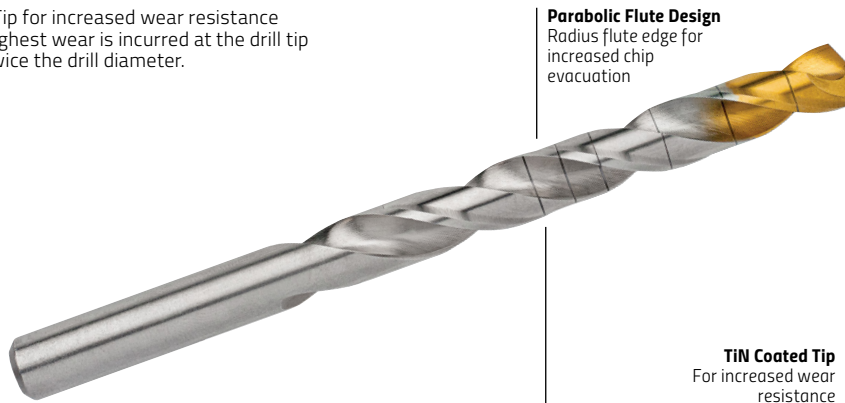

Parabolic Flute Design
Radius flute edge for increased chip evacuation

135° Split Point
Enables accurate positioning and less drilling pressure

TiN Coated Tip
For increased wear resistance delivering 3 x longer life

Drill depth indicator

Application

- DIY
- Trade
- Automotive
- Electrical
- Plumbing
- Carpentry
- General Contracting
- Woodworking
- Metalworking
- Machine Shop
- MRO

Discount Group: A0410

Diameter mm	O/A Length	Flute Length	Pack Qty	Item #	Barcode
Metric[^]	mm	mm			
1.0	34	12	2	165320394	9311744442492
1.5	40	18	2	165320591	9311744442508
2.0	49	24	2	165320787	9311744442515
2.5	57	30	2	165320984	9311744442522
3.0	61	33	2	165321181	9311744442539
3.5	70	39	1	165301378	9311744441303
4.0	75	43	1	165301575	9311744441310
4.5	80	47	1	165301772	9311744441327
5.0	86	52	1	165301968	9311744441334
5.5	93	57	1	165302165	9311744441341
6.0	93	57	1	165302362	9311744441358
6.5	101	63	1	165302559	9311744441365
7.0	109	69	1	165302756	9311744441372
7.5	109	69	1	165302953	9311744441389
8.0	117	75	1	165303150	9311744441396
8.5	117	75	1	165303346	9311744441402
9.0	125	81	1	165303543	9311744441419
9.5	125	81	1	165303740	9311744441426
10.0	133	87	1	165303937	9311744441433
10.5	133	87	1	165304134	9311744441440
11.0	142	94	1	165304331	9311744441457
11.5	142	94	1	165304528	9311744441464
12.0	151	101	1	165304724	9311744441471
12.5	151	101	1	165304921	9311744441488
13.0	151	101	1	165305118	9311744441495

Diameter inch	Diameter mm	O/A Length	Flute Length	Pack Qty	Item #	Barcode
Imperial[^]	mm	mm				
1/8	3.18	70	41	2	165421250	9311744442577
3/16	4.76	89	59	1	165401875	9311744441587
1/4	6.35	101	63	1	165402500	9311744441624
5/16	7.94	114	81	1	165403125	9311744441662
3/8	9.52	127	92	1	165403750	9311744441709
1/2	12.70	152	114	1	165405000	9311744441785

[^]New look packaging depicted. Actual product packaging may differ from image shown.

Drills Jobber Bulk Pack – TiN



Titanium Nitride (TiN) Coated Tip for increased wear resistance delivering 3X longer life. The highest wear is incurred at the drill tip and cutting edges to depths twice the drill diameter.

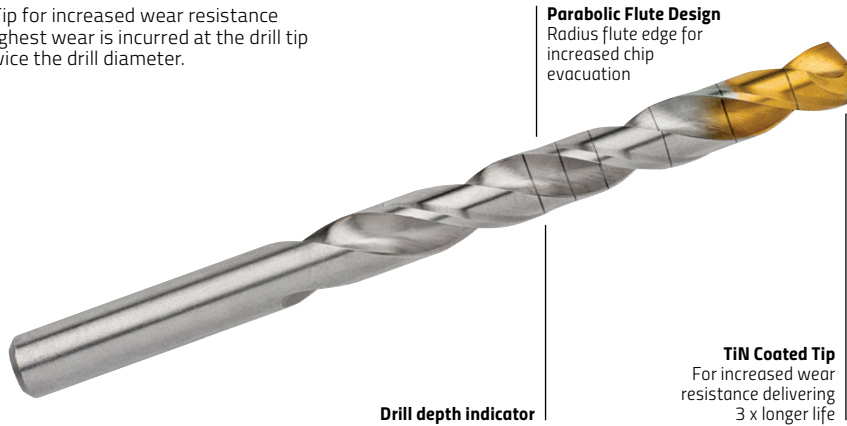

Parabolic Flute Design
Radius flute edge for increased chip evacuation

135° Split Point
Enables accurate positioning and less drilling pressure

TiN Coated Tip
For increased wear resistance delivering 3 x longer life

Drill depth indicator

- Application**
- DIY
 - Trade
 - Automotive
 - Electrical
 - Plumbing
 - Carpentry
 - General Contracting
 - Woodworking
 - Metalworking
 - Machine Shop
 - MRO

Section Index

Discount Group: A0402

Diameter mm	O/A Length	Flute Length	Pack Qty	Item #	Barcode
Metric^	mm	mm			
1.0	34	12	10	166310394	9311744443338
1.5	40	18	10	166310591	9311744443383
2.0	49	24	10	166310787	9311744443437
2.5	57	30	10	166310984	9311744443482
3.0	61	33	10	166311181	9311744443536
3.2	65	36	10	166311260	9311744443550
3.3	65	36	10	166311299	9311744443567
3.5	70	39	10	166311378	9311744443581
4.0	75	43	10	166311575	9311744443635
4.2	75	43	10	166311654	9311744443659
4.3	80	47	10	166311693	9311744443666
4.5	80	47	10	166311772	9311744443680
4.9	86	52	10	166311929	9311744443727
5.0	86	52	10	166311969	9311744443734
5.5	93	57	10	166312165	9311744443789
5.8	93	57	5	166312283	9311744443819
6.0	93	57	5	166312362	9311744443833
6.5	101	63	5	166312559	9311744443888
6.8	109	69	5	166312677	9311744443918
7.0	109	69	5	166312756	9311744443932
7.5	109	69	5	166312953	9311744443987
8.0	117	75	5	166313150	9311744444038
8.5	117	75	5	166313346	9311744444083
8.8	125	81	5	166313465	9311744444113
9.0	125	81	5	166313543	9311744444137
9.5	125	81	5	166313740	9311744444182
10.0	133	87	5	166313937	9311744444236
10.2	133	87	5	166314016	9311744444250
10.3	133	87	5	166314055	9311744444267
10.5	133	87	5	166314139	9311744444281
11.0	142	94	5	166314331	9311744444335
11.5	142	94	5	166314528	9311744444380
12.0	151	101	5	166314724	9311744444434
12.5	151	101	5	166314921	9311744444489
13.0	151	101	5	166315118	9311744444533

Diameter inch	O/A Length mm	Flute Length mm	Pack Qty	Item #	Barcode	
Imperial^	mm	mm				
1/16	1.59	48	22	10	166410624	9311744444540
5/64	1.98	51	25	10	166410781	9311744444557
3/32	2.38	57	32	10	166410928	9311744444564
7/64	2.78	67	38	10	166411094	9311744444571
1/8	3.18	70	41	10	166411250	9311744444588
9/64	3.57	73	44	10	166411406	9311744444595
5/32	3.97	79	51	10	166411563	9311744444601
11/64	4.37	83	54	10	166411719	9311744444618
3/16	4.76	89	59	10	166411875	9311744444625
13/64	5.16	92	62	10	166412031	9311744444632
7/32	5.56	95	64	10	166412188	9311744444649
15/64	5.95	98	67	5	166412344	93117444446209
1/4	6.35	101	63	5	166412500	9311744444656
17/64	6.75	105	73	5	166412656	93117444446216
9/32	7.14	108	75	5	166412813	93117444446223
19/64	7.54	111	78	5	166412969	93117444446230
5/16	7.94	114	81	5	166413125	9311744444663
21/64	8.33	117	84	5	166413281	93117444446247
11/32	8.73	121	87	5	166413438	93117444446254
23/64	9.13	124	89	5	166413594	93117444446261
3/8	9.52	127	92	5	166413750	9311744444670
25/64	9.92	130	95	5	166413906	93117444446278
13/32	10.32	133	98	5	166414063	93117444446285
27/64	10.72	137	100	5	166414219	93117444446315
7/16	11.11	140	103	5	166414375	93117444446292
29/64	11.51	143	106	5	166414531	93117444446322
15/32	11.91	146	110	5	166414688	93117444446339
31/64	12.30	149	111	5	166414844	93117444446346
1/2	12.70	152	114	5	166415000	9311744444687

^New look packaging depicted. Actual product packaging may differ from image shown.

Drills Jobber – Supabit Impact

suttontools

SUPABIT
EXTREME IMPACT

Supabits are developed for use with the high torque output of an impact driver and are suitable for general purpose use in metal, timber and plastics.



Check out the demo

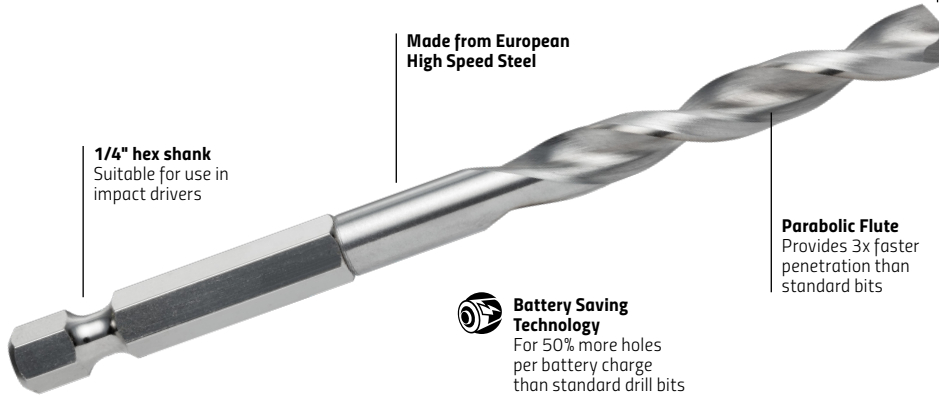

1/4" hex shank
Suitable for use in impact drivers

Made from European High Speed Steel

135° Split Point
Enables accurate positioning and less drilling pressure

Parabolic Flute
Provides 3x faster penetration than standard bits

Battery Saving Technology
For 50% more holes per battery charge than standard drill bits

Application

- DIY
- Trade
- Automotive
- Electrical
- Plumbing
- Carpentry
- General Contracting
- Woodworking
- Metalworking
- Machine Shop
- MRO

Discount Group: A0424

Diameter mm	O/A Length	Flute Length	Shank Inch	Pieces	Item #	Barcode
Metric	mm	mm				D183
2.0	53	18	1/4	1	D183 0200	9311963599762
2.5	58	22	1/4	1	D183 0250	9311963599779
3.0	63	26	1/4	1	D183 0300	9311963599786
3.5	68	28	1/4	1	D183 0350	9311963599793
4.0	73	30	1/4	1	D183 0400	9311963599809
4.5	78	33	1/4	1	D183 0450	9311963599816
5.0	83	36	1/4	1	D183 0500	9311963599823
5.5	88	40	1/4	1	D183 0550	9311963599830
6.0	93	47	1/4	1	D183 0600	9311963599847
6.5	98	50	1/4	1	D183 0650	9311963599854
7.0	100	62	1/4	1	D183 0700	9311963599861
8.0	105	65	1/4	1	D183 0800	9311963599878
9.0	110	68	1/4	1	D183 0900	9311963599953
10.0	115	71	1/4	1	D183 1000	9311963599960
11.0	120	74	1/4	1	D183 1100	9311963599977
12.0	125	77	1/4	1	D183 1200	9311963599984
13.0	130	80	1/4	1	D183 1300	9311963599991
Supabit Impact HSS Drill Set						
5 Pce Set: 2, 3, 4, 5, 6mm				5	D183 0005	9311963601144



D183 0005

Drills Jobber – Quickbits® Impact



Designed for machine and hand held drilling in a wide range of ferrous and non-ferrous materials.

118° Standard Point
Common point for general purpose applications



Shank
1/4" hex shank suits impact drivers and quick change adaptors

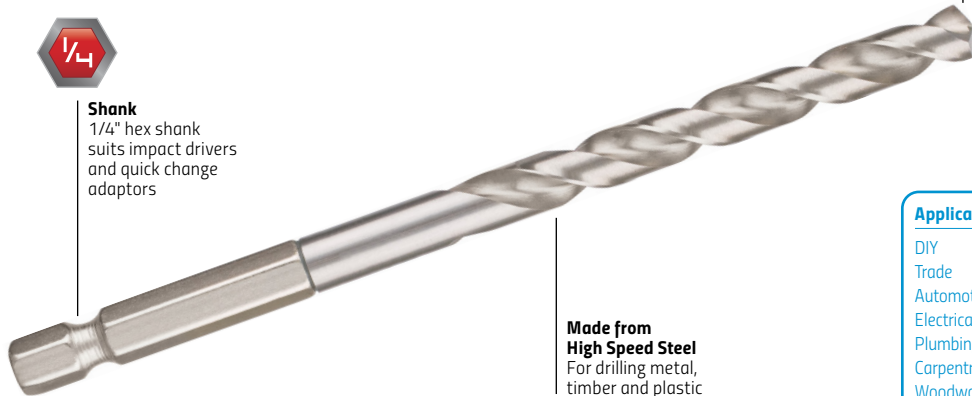

Made from High Speed Steel
For drilling metal, timber and plastic

- Application**
- DIY
 - Trade
 - Automotive
 - Electrical
 - Plumbing
 - Carpentry
 - Woodworking
 - Metalworking

Discount Group: A0424

Diameter mm	O/A Length	Flute Length	Shank Inch	Pieces	Item #	Barcode
Metric	mm	mm				
2.0	53	18	1/4	1	107B80020	9311744439898
2.5	58	22	1/4	1	107B80025	9311744439904
3.0	63	26	1/4	1	107B80030	9311744439911
3.2	68	28	1/4	1	107B80032	9311744439928
3.5	68	28	1/4	1	107B80035	9311744439935
4.0	73	30	1/4	1	107B80040	9311744439942
4.5	78	33	1/4	1	107B80045	9311744439959
5.0	83	36	1/4	1	107B80050	9311744439966
5.5	88	40	1/4	1	107B80055	9311744439973
6.0	93	47	1/4	1	107B80060	9311744439997
6.5	98	50	1/4	1	107B80065	9311744440009
7.0	100	62	1/4	1	107B80070	9311744440016
8.0	105	65	1/4	1	107B80080	9311744440023
9.0	110	68	1/4	1	107B80090	9311744440030
10.0	115	71	1/4	1	107B80100	9311744440047
12.0	125	77	1/4	1	107B80120	9311744440054
Quickbits® Impact HSS Drill Set						
5 Pce Set: 2, 3, 4, 5, 6mm			1/4	5	107B8SET5	9311744441860



107B8SET5

Section Index

Drills Quickbits® - Fixed Shank



HSS Drill Sets for metal, wood and plastic. Designed for machine and hand held drilling in a wide range of ferrous and non-ferrous materials.

118° Standard Point
Common point for general purpose applications



Shank
1/4" hex shank
suits quick change
adaptors



Made from High Speed Steel
For drilling metal,
timber and
plastic

Discount Group: A0424

Description	Shank Inch	Pieces	Item #	Barcode
Fixed Hex Shank Drill Set Drill, Countersink & Screwdriver Set Drills: 1.95, 2.5, 3, 3.6, 4, 4.6, 5mm + Adaptor, HSS Countersink, 9 x 50mm Screwdriver Bits: PH1, PH2, PH3, PZ1, PZ2, PZ3, SL4, SL5 & SL6	1/4	19	150B0FHEX	9311744026395



150B0FHEX

Drills Quickbits® - Changeable



Designed for machine and hand held drilling in a wide range of ferrous and non-ferrous materials. Removable drill for easy replacement.



Shank
1/4" hex shank
suits quick change
adaptors

Removable Drill
For easy
replacement

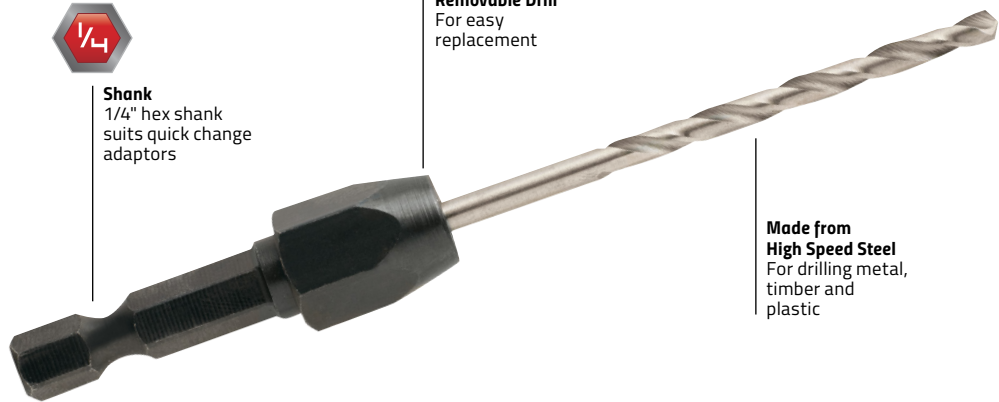

Made from High Speed Steel
For drilling metal,
timber and
plastic

Section Index

Discount Group: A0424

Diameter mm	Diameter Inch	O/A Length	Flute Length	Shank Inch	Pieces	Item #	Barcode
Changeable Drills							
2.0		49	24	1/4	1	107B50020	9311744436699
3.0		61	33	1/4	1	107B50030	9311744436705
4.0		75	43	1/4	1	107B50040	9311744436712
5.0		86	52	1/4	1	107B50050	9311744436729
6.0		93	57	1/4	1	107B50060	9311744436736
1.98	5/64	51	25	1/4	1	107B50781	9311744436743
3.18	1/8	70	41	1/4	1	107B51250	9311744436750
3.97	5/32	79	51	1/4	1	107B51563	9311744436767
4.76	3/16	89	59	1/4	1	107B51875	9311744436774
6.35	1/4	101	63	1/4	1	107B52500	9311744436781
Drill Adaptors							
2.9-3.2	1/8			1/4	1	107B11250	9311744436361
3.7-4.0	5/32			1/4	1	107B11563	9311744436385
4.5-4.8	3/16			1/4	1	107B11875	9311744436408
Changeable Drill Sets							
Metric: 2.0, 3.0, 4.0, 5.0 & 6.0 + 5/8" Countersink				1/4	6	150BSET6M	9311744435494
Imperial: 5/64, 1/8, 5/32, 3/16 & 1/4 + 5/8" Countersink				1/4	6	150BSET6I	9311744435500



107B11250



150BSET6M



150BSET6I

Drills Long Series

suttontools

118° Standard Point
Common point for general purpose applications

Offers longer flute and overall length than standard drill bits. Ideal for drilling deeper holes.

Section Index

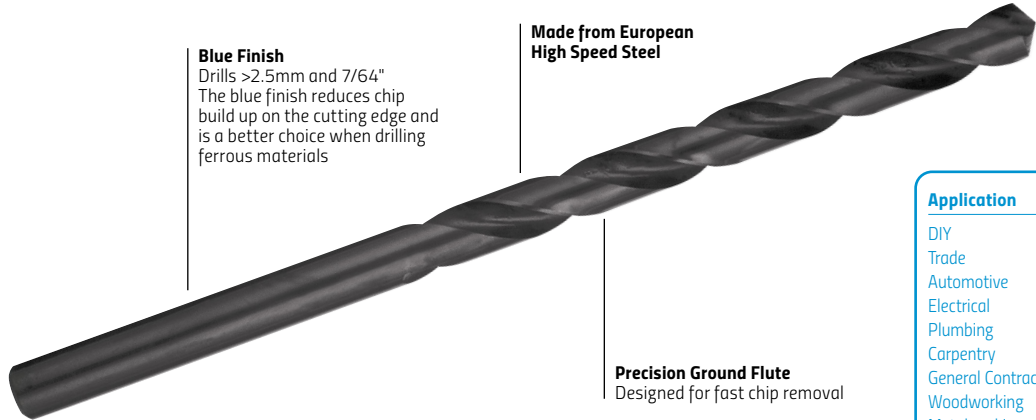

Blue Finish
Drills >2.5mm and 7/64"
The blue finish reduces chip build up on the cutting edge and is a better choice when drilling ferrous materials

Made from European High Speed Steel

Precision Ground Flute
Designed for fast chip removal

Application

- DIY
- Trade
- Automotive
- Electrical
- Plumbing
- Carpentry
- General Contracting
- Woodworking
- Metalworking
- Machine Shop
- MRO

Discount Code: A0502

Diameter mm	O/A Length	Flute Length	Pieces	Item #	Barcode
Metric	mm	mm		D110	
2.0*	108	57	1	D110 0200	9311963066998
2.5*	117	64	1	D110 0250	9311963067001
3.0	130	70	1	D110 0300	9311963017211
3.3	137	76	1	D110 0330	9311963019819
3.5	137	76	1	D110 0350	9311963016016
4.0	146	86	1	D110 0400	9311963022918
4.5	146	86	1	D110 0450	9311963016023
5.0	152	92	1	D110 0500	9311963018539
5.5	152	92	1	D110 0550	9311963017228
6.0	156	95	1	D110 0600	9311963016030
6.5	159	98	1	D110 0650	9311963017235
7.0	159	98	1	D110 0700	9311963022925
7.5	162	102	1	D110 0750	9311963026633
8.0	165	105	1	D110 0800	9311963017242
8.5	165	105	1	D110 0850	9311963024592
9.0	171	105	1	D110 0900	9311963028804
9.5	171	105	1	D110 0950	9311963034966
10.0	178	111	1	D110 1000	9311963011103
10.5	184	117	1	D110 1050	9311963016047
11.0	184	117	1	D110 1100	9311963018546
11.5	184	117	1	D110 1150	9311963188898
12.0	197	121	1	D110 1200	9311963026657
12.5	197	121	1	D110 1250	9311963039367
13.0	197	121	1	D110 1300	9311963028811
6 Pce Long Series Drill Set					
3, 4, 5, 6, 8, 10mm			6	D110 0006	9311963611211

Diameter inch	Diameter mm	O/A Length	Flute Length	Pieces	Item #	Barcode
Imperial	mm	mm			D110	
1/16*	1.59	76	44	1	D110 0159	9311963010625
5/64*	1.98	95	51	1	D110 0198	9311963016009
3/32*	2.38	117	57	1	D110 0238	9311963010632
7/64*	2.78	130	64	1	D110 0278	9311963015156
1/8	3.18	137	70	1	D110 0318	9311963001814
9/64	3.57	137	76	1	D110 0357	9311963009391
5/32	3.97	137	76	1	D110 0397	9311963001340
11/64	4.37	146	86	1	D110 0437	9311963011073
3/16	4.76	152	92	1	D110 0476	9311963001531
13/64	5.16	152	92	1	D110 0516	9311963008486
7/32	5.56	152	92	1	D110 0556	9311963006475
15/64	5.95	156	95	1	D110 0595	9311963018515
1/4	6.35	156	95	1	D110 0635	9311963000978
17/64	6.75	159	98	1	D110 0676	9311963019802
9/32	7.14	159	98	1	D110 0714	9311963021294
19/64	7.54	162	102	1	D110 0754	9311963022895
5/16	7.94	162	102	1	D110 0794	9311963002361
21/64	8.33	165	105	1	D110 0833	9311963026596
11/32	8.73	165	105	1	D110 0873	9311963026602
23/64	9.13	171	108	1	D110 0913	9311963021300
3/8	9.52	171	108	1	D110 0953	9311963003894
25/64	9.92	178	111	1	D110 0992	9311963026619
13/32	10.32	178	111	1	D110 1032	9311963011080
27/64	10.72	184	117	1	D110 1072	9311963024585
7/16	11.11	184	117	1	D110 1111	9311963012216
29/64	11.51	184	117	1	D110 1151	9311963022901
15/32	11.91	184	117	1	D110 1191	9311963034959
31/64	12.30	197	121	1	D110 1231	9311963018522
1/2	12.70	197	121	1	D110 1269	9311963006277
9/16†	14.29	209	124	1	D110 1429	9311963089584
5/8†	15.88	222	125	1	D110 1588	9311963089607
3/4†	19.05	234	149	1	D110 1905	9311963089591

†Tube Pack



D110 0006

*Bright Finish < 3mm. Note: Bulk packs available on request, subject to lead times.

Drills Long Series – Extra Long Reach

suttontools

300mm overall length for drilling deep holes in long reach applications.

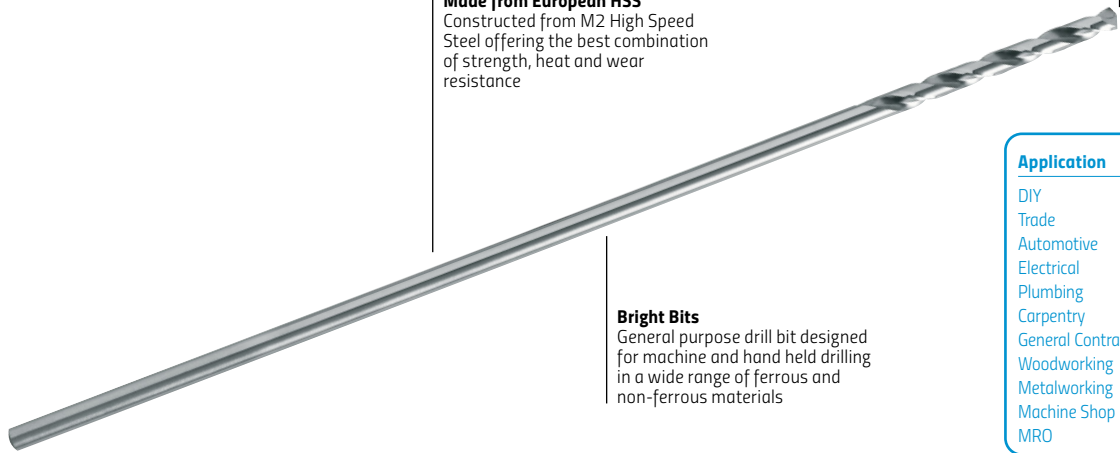

135° Split Point
Minimises wandering when starting

Made from European HSS
Constructed from M2 High Speed Steel offering the best combination of strength, heat and wear resistance

Bright Bits
General purpose drill bit designed for machine and hand held drilling in a wide range of ferrous and non-ferrous materials

Application
DIY
Trade
Automotive
Electrical
Plumbing
Carpentry
General Contracting
Woodworking
Metalworking
Machine Shop
MRO

Discount Code: A0502

Diameter mm	O/A Length	Flute Length	Item #	Barcode
Metric	mm	mm	D187	
3.0	300	40	D187 0030	9311963621869
4.0	300	50	D187 0040	9311963621876
5.0	300	60	D187 0050	9311963621883
6.0	300	65	D187 0060	9311963621890
8.0	300	80	D187 0080	9311963621920
10.0	300	92	D187 0100	9311963621937
12.0	300	109	D187 0120	9311963621944
13.0	300	118	D187 0130	9311963622330

Diameter inch	O/A Length	Flute Length	Item #	Barcode
Imperial	mm	mm	D187	
1/8	3.18	300	D187 0318	9311963021461
3/16	4.76	300	D187 0476	9311963022116
1/4	6.35	300	D187 0635	9311963022765
5/16	7.94	300	D187 0794	9311963023014
3/8	9.52	300	D187 0953	9311963023021
7/16	11.11	300	D187 1111	9311963023038
1/2	12.70	300	D187 1269	9311963023687

Note: Bulk packs available on request, subject to lead times.

Drills Mini Hand Drill

suttontools

For hand drilling soft metals, wood and plastic. Designed for metal working, electronics, jewellery, model engineering and general hobby work. Drill bits made from High Speed Steel.



Hollow Alloy Body
Stores drills when not in use

HSS
Drills made from High Speed Steel

Knurled End
For drilling control

Application
DIY
Trade
Automotive
Electronics
Woodworking
Metalworking

Discount Group: A1202

Description	Pieces	Item #	Barcode
11 Pce Tip Tool Drill Kit Includes Drill sizes 0.60, 0.70, 0.80, 0.90, 1.00, 1.10, 1.20, 1.30, 1.40, 1.50, 1.60mm	11	D201 0012	9311963177090

Drills Reduced Shank – Sets

suttontools

Precision ground flute - bright cutting edge with blue flute making it a better choice when drilling ferrous materials.

Use low speed, 350RPM or less.

Secure workpiece and drill firmly.

Discount Code: A1202

Set	Contents	Case	Pieces	Item #	Barcode
Metric					
D188					
RS4M	16.0, 18.0, 22.0, 25.0mm with 12.5mm shanks	Foam	4	D188 RS4M	9311963333472
SM8R	14.0, 15.0, 16.0, 16.5, 18.0, 20.0, 22.0, 25.0mm with 12.5mm shanks	Plastic	8	D188 SM8R	9311963191522
Imperial					
RS4	5/8, 3/4, 7/8, 1 with 1/2" shanks	Foam	4	D188 RS4	9311963333458
S8R	9/16, 5/8, 11/16, 3/4, 13/16, 7/8, 15/16, 1 with 1/2" shanks	Plastic	8	D188 S8R	9311963191515
RS16	17/32, 9/16, 19/32, 5/8, 21/32, 11/16, 23/32, 3/4, 25/32, 13/16, 27/32, 7/8, 29/32, 15/16, 31/32, 1 with 1/2" shanks	Plastic	16	D188 RS16	9311963401188



D188 RS4M



D188 RS4



D188 SM8R



D188 S8R



D188 RS16

Note: Overall and flute lengths do not include drill point.

Drills Reduced Shank

suttontools

Precision ground flute - bright cutting edge with blue flute making it a better choice when drilling ferrous materials.

Use low speed, 350RPM or less.

Secure workpiece and drill firmly.



Size
152mm (6") overall length with
a 86mm (3-3/8") flute length

Reduced Shank
Drill sizes above 12.5mm and
1/2" feature reduced shanks
to suit 13mm drill chucks

**Made from European
High Speed Steel**

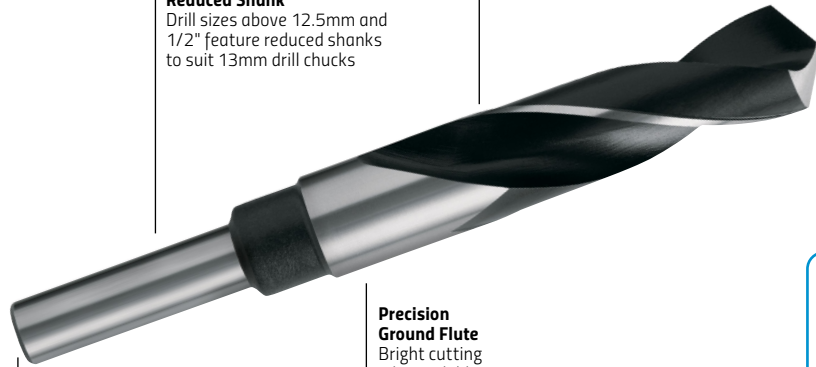

**Precision
Ground Flute**
Bright cutting
edge with blue
flute making it
a better choice
when drilling
ferrous materials

118° Standard Point
Common point for general
purpose applications

Application
DIY
Trade
Industrial Application
Automotive
Metalworking
Machine Shop
MRO

Discount Code: A0906

Diameter mm	O/A Length	Flute Length	Shank Inch	Item #	Barcode
Metric	mm	mm		D188	
13.5	152	86	1/2	D188 1350	9311963011646
14.0	152	86	1/2	D188 1400	9311963005300
14.5	152	86	1/2	D188 1450	9311963008752
15.0	152	86	1/2	D188 1500	9311963007793
15.5	152	86	1/2	D188 1550	9311963011141
16.0	152	86	1/2	D188 1600	9311963004990
16.5	152	86	1/2	D188 1650	9311963007809
17.0	152	86	1/2	D188 1700	9311963008769
17.5	152	86	1/2	D188 1750	9311963009872
18.0	152	86	1/2	D188 1800	9311963008776
18.5	152	86	1/2	D188 1850	9311963019925
19.0	152	86	1/2	D188 1900	9311963008097
19.5	152	86	1/2	D188 1950	9311963017358
20.0	152	86	1/2	D188 2000	9311963004624
20.5	152	86	1/2	D188 2050	9311963028965
21.0	152	86	1/2	D188 2100	9311963011653
21.5	152	86	1/2	D188 2150	9311963031736
22.0	152	86	1/2	D188 2200	9311963007489
22.5	152	86	1/2	D188 2250	9311963028972
23.0	152	86	1/2	D188 2300	9311963013510
23.5	152	86	1/2	D188 2350	9311963035154
24.0	152	86	1/2	D188 2400	9311963011660
24.5	152	86	1/2	D188 2450	9311963024677
25.0	152	86	1/2	D188 2500	9311963012315
26.0	152	86	1/2	D188 2600	9311963087566
28.0	152	86	1/2	D188 2800	9311963087573
30.0	152	86	1/2	D188 3000	9311963087580

Diameter inch	O/A Length mm	Flute Length mm	Shank Inch	Item #	Barcode
Imperial	mm	mm		D188	
33/64	13.10	152	86 1/2	D188 1310	9311963352565
17/32	13.49	152	86 1/2	D188 1349	9311963001937
35/64	13.89	152	86 1/2	D188 1389	9311963352572
9/16	14.29	152	86 1/2	D188 1429	9311963000893
37/64	14.68	152	86 1/2	D188 1468	9311963352589
19/32	15.08	152	86 1/2	D188 1508	9311963003436
39/64	15.48	152	86 1/2	D188 1548	9311963352596
5/8	15.87	152	86 1/2	D188 1588	9311963000237
41/64	16.27	152	86 1/2	D188 1627	9311963352602
21/32	16.67	152	86 1/2	D188 1667	9311963001692
43/64	17.06	152	86 1/2	D188 1707	9311963352619
11/16	17.46	152	86 1/2	D188 1746	9311963001081
45/64	17.86	152	86 1/2	D188 1786	9311963352626
23/32	18.26	152	86 1/2	D188 1826	9311963004617
47/64	18.65	152	86 1/2	D188 1865	9311963352633
3/4	19.05	152	86 1/2	D188 1905	9311963000855
49/64	19.45	152	86 1/2	D188 1945	9311963352640
25/32	19.84	152	86 1/2	D188 1984	9311963004167
51/64	20.24	152	86 1/2	D188 2024	9311963352657
13/16	20.64	152	86 1/2	D188 2064	9311963003535
27/32	21.43	152	86 1/2	D188 2143	9311963010250
7/8	22.22	152	86 1/2	D188 2223	9311963001234
29/32	23.02	152	86 1/2	D188 2302	9311963008745
15/16	23.81	152	86 1/2	D188 2381	9311963004853
31/32	24.61	152	86 1/2	D188 2461	9311963010656
1	25.40	152	86 1/2	D188 2540	9311963001388
1-1/16	26.99	152	86 1/2	D188 2699	9311963006321
1-1/8	28.57	152	86 1/2	D188 2858	9311963004075
1-3/16	30.16	152	86 1/2	D188 3016	9311963010663
1-1/4	31.75	152	86 1/2	D188 3175	9311963003900
3/8 Reduced Shank				D120	
9/16	14.29	152	86 3/8	D120 1429	9311963001371
5/8	15.87	152	86 3/8	D120 1588	9311963000565
3/4	19.05	152	86 3/8	D120 1905	9311963002439

Note: Overall and flute lengths do not include drill point.

Drills Panel & Rivet – Single Ended

suttontools

Developed to drill holes for rivets in flat and curved panels used in sheet metal fabrication.

Packaging, available in twin or trade (10) pack.

135° Self Centring Point
Minimises wandering when starting

Made from European High Speed Steel

Flute Length
Designed for shallow hole drilling no deeper than 1.25mm x diameter

Application

DIY
Trade
Automotive
Electrical
Plumbing
General Contracting
Metalworking
MRO



Hang Pack

Discount Group: A0802



Diameter inch/#	mm	O/A Length	Flute Length	Order Qty	Item #	Barcode
Bright Finish		mm	mm			
Carded – 2 Pack						
D131						
1/8	3.18	54.0	19.1	1	D131 0318	93223140
#30	3.26	54.0	19.1	1	D131 0326	93223157
#20	4.09	54.0	22.2	1	D131 0409	93223164
#11	4.85	54.0	22.2	1	D131 0485	93223171
Hang Pack – 10 Pack						
D132						
1/8	3.18	54.0	19.1	1	D132 0318	9311963193717
#30	3.26	54.0	19.1	1	D132 0326	9311963193724
#20	4.09	54.0	22.2	1	D132 0409	9311963193731
#11	4.85	54.0	22.2	1	D132 0485	9311963193748
Quad Pack – 10 Pack						
D121						
1/8	3.18	54.0	19.1	10	D121 0318	9311963007205
#30	3.26	54.0	19.1	10	D121 0326	9311963002002
#20	4.09	54.0	22.2	10	D121 0409	9311963008479
#11	4.85	54.0	22.2	10	D121 0485	9311963003276



Diameter inch/#	mm	O/A Length	Flute Length	Order Qty	Item #	Barcode
Blue Finish		mm	mm			
Quad Pack – 10 Pack						
D124						
1/8	3.18	54.0	19.1	10	D124 0318	9311963105543
#30	3.26	54.0	19.1	10	D124 0326	9311963034942
#20	4.09	54.0	22.2	10	D124 0409	9311963105550
#11	4.85	54.0	22.2	10	D124 0485	9311963105567



Discount Group: A1002

Diameter inch/#	mm	O/A Length	Flute Length	Order Qty	Item #	Barcode
Bright Finish - Stub 118° Split Point						
Quad Pack – 10 Pack						
D123						
1/8	3.18	47.6	22.2	10	D123 0318	9311963004495
#30	3.26	49.2	23.8	10	D123 0326	9311963001333
#20	4.09	54.0	27.0	10	D123 0409	9311963006000
#11	4.85	57.2	30.2	10	D123 0485	9311963002255



Discount Group: A1002

Diameter inch/#	mm	O/A Length	Flute Length	Order Qty	Item #	Barcode
Blue Finish - Stub 118° Split Point						
Quad Pack – 10 Pack						
D126						
1/8	3.18	47.6	22.2	10	D100 0318	9311963007731
#30	3.26	49.2	23.8	10	D126 0326	9311963026589
#20	4.09	54.0	27.0	10	D126 0409	9311963107196
#11	4.85	57.2	30.2	10	D126 0485	9311963034935

Rivet Chart

Rivet Size	Drill Diameter
3.0mm	1/8 (3.18mm)
1/8"	# 30 (3.26mm)
4.0mm & 5/32"	# 20 (4.09mm)
3/16"	# 11 (4.85mm)

Note: Drill diameter is larger than rivet size to allow clearance.

Note: Overall and flute lengths do not include drill point.

Drills Panel & Rivet – Double Ended

suttontools

Developed to drill holes for rivets in flat and curved panels used in sheet metal fabrication.

135° Self Centring Point
Minimises wandering when starting



Hang Pack

Double Ended
Tupoint increases drill life. Ensure that the chuck jaws are fully tightened

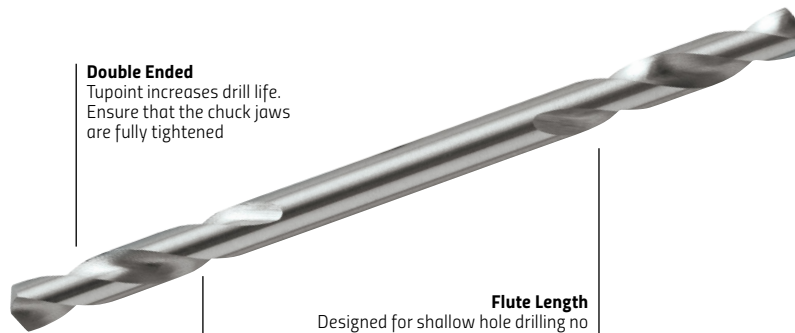

Flute Length
Designed for shallow hole drilling no deeper than 1.25mm x diameter

Made from European High Speed Steel

Application
DIY
Trade
Automotive
Electrical
Plumbing
General Contracting
Metalworking
MRO

Discount Group: A0802



Diameter	O/A	Flute	Order	Item #	Barcode
inch/#	mm	Length	Length	Qty	
Bright Finish		mm	mm		
Carded – 2 Pack					
D133					
1/8	3.18	54.0	15.9	1	D133 0318 93223188
#30	3.26	54.0	15.9	1	D133 0326 93223195
#20	4.09	54.0	15.9	1	D133 0409 93223201
#11	4.85	54.0	15.9	1	D133 0485 93223218
Hang Pack – 10 Pack					
D134					
1/8	3.18	54.0	15.9	1	D134 0318 9311963193755
#30	3.26	54.0	15.9	1	D134 0326 9311963193762
#20	4.09	54.0	15.9	1	D134 0409 9311963193779
#11	4.85	54.0	15.9	1	D134 0485 9311963193786
Quad Pack – 10 Pack					
D122					
1/8	3.18	54.0	15.9	10	D122 0318 9311963000671
#30	3.26	54.0	15.9	10	D122 0326 9311963000145
#20	4.09	54.0	15.9	10	D122 0409 9311963001500
#11	4.85	54.0	15.9	10	D122 0485 9311963000701



Diameter	O/A	Flute	Order	Item #	Barcode
inch/#	mm	Length	Length	Qty	
Blue Finish		mm	mm		
Quad Pack – 10 Pack					
D125					
1/8	3.18	54.0	15.9	10	D125 0318 9311963063393
#30	3.26	54.0	15.9	10	D125 0326 9311963039343
#20	4.09	54.0	15.9	10	D125 0409 9311963105574
#11	4.85	54.0	15.9	10	D125 0485 9311963105581



Diameter	O/A	Flute	Order	Item #	Barcode
inch/#	mm	Length	Length	Qty	
Cobalt High Speed Steel					
Quad Pack – 10 Pack					
D130					
1/8	3.18	54.0	15.9	10	D130 0318 9311963064338
#30	3.26	54.0	15.9	10	D130 0326 9311963064345
#20	4.09	54.0	15.9	10	D130 0409 9311963064352
#11	4.85	54.0	15.9	10	D130 0485 9311963064369

Rivet Chart

Rivet Size	Drill Diameter
3.0mm	1/8 (3.18mm)
1/8"	# 30 (3.26mm)
4.0mm & 5/32"	# 20 (4.09mm)
3/16"	# 11 (4.85mm)

Note: Drill diameter is larger than rivet size to allow clearance.

Drills Panel & Rivet – Double Ended



Developed to drill holes for rivets in flat and curved panels and used in sheet metal fabrication.



Double Ended
Increases drill life.
Ensure that the chuck jaws
are fully tightened

TiN Coated Tip
For increased
wear resistance
delivering
3 x longer life



**135° Self
Centring Point**
Minimises
wandering when
starting

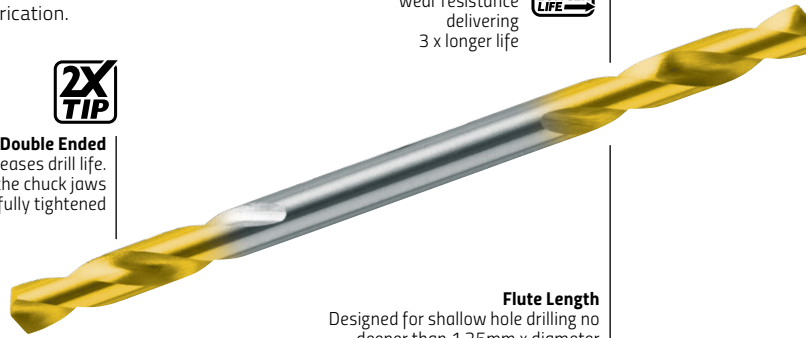

Flute Length
Designed for shallow hole drilling no
deeper than 1.25mm x diameter

Application

DIY
Trade
Automotive
Electrical
Plumbing
General Contracting
Metalworking
MRO

Discount Group: A0806

Diameter inch/#	mm	O/A Length	Flute Length	Rivet Size	Pieces	Item #	Barcode
Bulk – 10 Pack[^]		mm	mm				
1/8	3.18	54.0	15.9	3.0mm	10	165611250	9311744442454
#30	3.26	54.0	15.9	1/8	10	165611285	9311744442461
#20	4.09	54.0	15.9	4.0mm & 5/32	10	165611610	9311744442478
#11	4.85	54.0	15.9	3/16	10	165611910	9311744442485

Made from M2 High Speed Steel. 135° modified point design. Fully tested and approved by Sutton Tools R&D department.

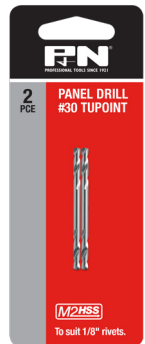

Double Ended
Increases drill life.
Ensure that the chuck jaws
are fully tightened

135° Self Centring Point
Minimises wandering when starting

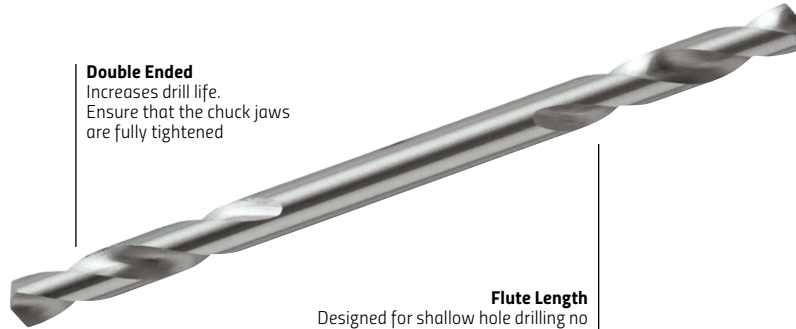

Flute Length
Designed for shallow hole drilling no
deeper than 1.25mm x diameter

Discount Group: A0802

Diameter #	mm	O/A Length	Flute Length	Rivet Size	Pieces	Item #	Barcode
Carded – 2 Pack		mm	mm				
#30	3.26	54.0	15.9	1/8	2	166044645	9311744446452
Bulk – 10 Pack							
#30	3.26	54.0	15.9	1/8	10	166044646	9311744446469

Drills Panel & Rivet – Hex Shank



Diameter inch/#	mm	O/A Length	Flute Length	Rivet Size	Shank Inch	Pieces	Item #	Barcode
Panel Drill Sets								
1/8	3.18	67	24	3mm	1/4	5	107BSTB18	9311744436309
#30	3.26	67	24	1/8	1/4	5	107BSTB30	9311744436293

Discount Group: A0424

Rivet Chart

Rivet Size	Drill Diameter
3.0mm	1/8 (3.18mm)
1/8"	# 30 (3.26mm)
4.0mm & 5/32"	# 20 (4.09mm)
3/16"	# 11 (4.85mm)

Note: Drill diameter is larger than rivet size to allow clearance.

[^]New look packaging depicted. Actual product packaging may differ from image shown.

suttontools

Spot Weld Drills are designed for vehicle body repairs. For quick and precise drilling through existing auto panel spot welds, releasing damaged panels and enabling replacements to be fitted. Spot Weld Drills have a spur point designed to cut through the weld on one panel while leaving only a slight mark in the second panel.



HSS Co

Suitable for hand drills and spot weld pneumatic disconnectors. Cutting Speed: 500 – 800 RPM.

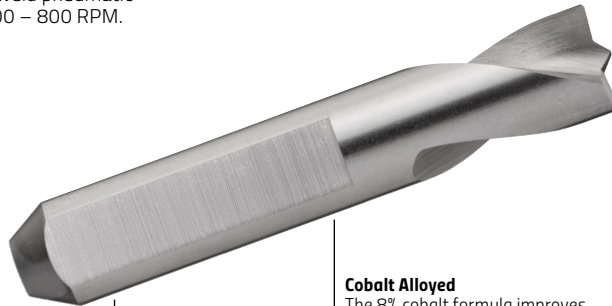

Centre Nib
Enables accurate positioning and less drilling pressure without work hardening

Shallow point design
Cuts through top panel while only slightly marking second panel

Cobalt Alloyed
The 8% cobalt formula improves abrasive and heat resistance, for increased strength at higher drilling temperatures

Flat Shank

Application
DIY
Trade
Automotive

Discount Group: A0802

Diameter mm	O/A Length	Flute Length	Material	Shank	Item #	Barcode
Hand Drills						D203
6.0	66	30	HSS Co5		D203 0060	9311963607214
8.0	79	33	HSS Co5		D203 0080	9311963607221
Pneumatic Disconnectors						D204
8.0	38	15	HSS Co8	Flat	D204 0080	9311963607238
						D205
6.0	45	14	HSS Co8	Flat	D205 0060	9311963607245
8.0	45	16	HSS Co8	Flat	D205 0080	9311963607252

suttontools

For use in sheet metal, aluminium, plastic and fibre glass, ideal for sheet metal without pre-drilling. During drilling, the next step deburrs the previously drilled hole.

Fixed Drilling Steps
Spiral Flute for reduced vibration and greater control through steps

Made from HSS
Constructed from M2 High Speed Steel offering the best combination of strength, heat and wear resistance

Flat Shank
Three flats suits 3-jaw chuck

Application

- DIY
- Trade
- Electrical
- Plumbing

Discount Group: A1104

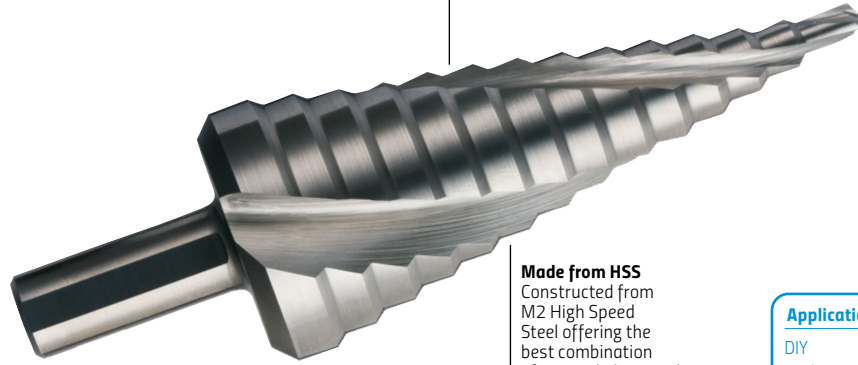

Diameter Range	Steps	Diameters	Shank	Pieces	Item #	Barcode
Metric						
D504						
4-12	5	4, 6, 8, 10, 12mm	Flat	1	D504 41205	9311744445929
4-12	9	4, 5, 6, 7, 8, 9, 10, 11, 12mm	Flat	1	D504 41209	9311744437474
4-20	9	4, 6, 8, 10, 12, 14, 16, 18, 20mm	Flat	1	D504 42009	9311744437481
4-22	10	4, 6, 8, 10, 12, 14, 16, 18, 20, 22mm	Flat	1	D504 42210	9311744445943
4-30	14	4, 6, 8, 10, 12, 14, 16, 18, 20, 22, 24, 26, 28, 30mm	Flat	1	D504 43014	9311744437498
5-35	13	5, 7.5, 10, 13, 16, 19, 21, 23, 26, 29, 31, 33, 35mm	Flat	1	D504 53513	9311744445950
6-18	7	6, 8, 10, 12, 14, 16, 18mm	Flat	1	D504 61807	9311744445936
6-36	11	6, 9, 12, 15, 18, 21, 24, 27, 30, 33, 36mm	Flat	1	D504 63611	9311744437504
Imperial						
1/8-1/2"	13	1/8, 5/32, 3/16, 7/32, 1/4, 9/32, 5/16, 11/32, 3/8, 13/32, 7/16, 15/32, 1/2"	Flat	1	D504 31313	9311744445967
3/16-1/2"	6	3/16, 1/4, 5/16, 3/8, 7/16, 1/2"	Flat	1	D504 51306	9311744445974
1/4-3/4"	9	1/4, 5/16, 3/8, 7/16, 1/2, 9/16, 5/8, 11/16, 3/4"	Flat	1	D504 61909	9311744445981
3 Pce Set						
Includes:						
4-12	9	4, 5, 6, 7, 8, 9, 10, 11, 12mm	Flat	3	D504 SET3	9311744445912
4-20	9	4, 6, 8, 10, 12, 14, 16, 18, 20mm				
4-30	14	4, 6, 8, 10, 12, 14, 16, 18, 20, 22, 24, 26, 28, 30mm				



D504 SET3

Drills Step Drills



For use in sheet metal, aluminium, plastic and fibre glass, ideal for sheet metal without pre-drilling. During drilling, the next step deburrs the previously drilled hole.



Hex Shank
1/4" hex shank suits quick change adaptors

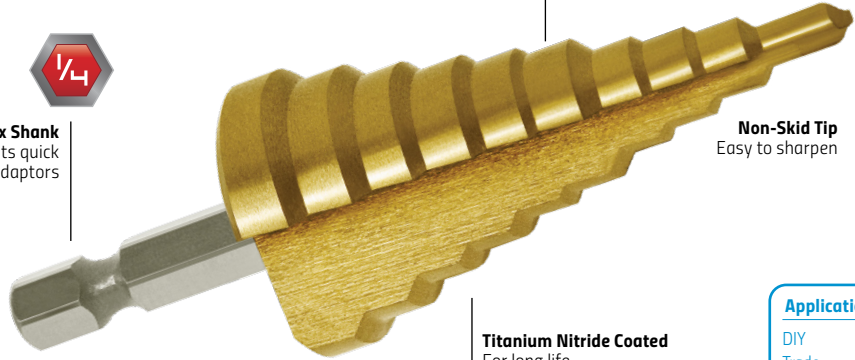

Fixed Drilling Steps
Two straight fluted cutting edges for greater control through steps

Non-Skid Tip
Easy to sharpen

Titanium Nitride Coated
For long life

Application

- DIY
- Trade
- Electrical
- Plumbing

Discount Group: A1104

Diameter Range	Steps	Diameters	Shank Inch	Item #	Barcode
4-12	8	4, 5, 6, 7, 8, 10, 11, 12mm	1/4	149040120	9311744435135
4-25	11	4, 6, 8, 10, 12, 14, 16, 18, 20, 22, 25mm	1/4	149040250	9311744435142
5/32-1/2"	12	5/32, 3/16, 7/32, 1/4, 9/32, 5/16, 11/32, 3/8, 13/32, 7/16, 15/32, 1/2"	1/4	149010032	9311744435159
5/32-1"	10	5/32, 1/4, 5/16, 3/8, 1/2, 9/16, 21/32, 3/4, 7/8, 1"	1/4	149010064	9311744435166



For use in sheet metal, aluminium, plastic and fibre glass, ideal for sheet metal without pre-drilling. During drilling, the next step deburrs the previously drilled hole.

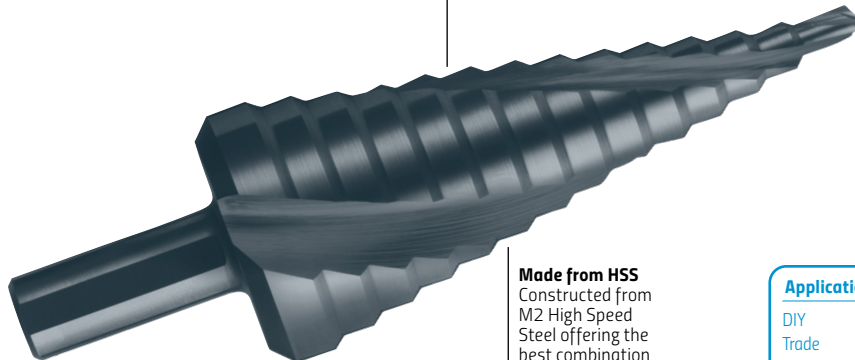

Fixed Drilling Steps
Spiral Flute for reduced vibration and greater control through steps

Made from HSS
Constructed from M2 High Speed Steel offering the best combination of strength, heat and wear resistance

Application

- DIY
- Trade
- Electrical
- Plumbing

Flat Shank
Three flats suits 3-jaw chuck

Discount Group: A1104

Diameter Range	Steps	Diameters	Shank	Item #	Barcode
4-12^	9	4, 5, 6, 7, 8, 9, 10, 11, 12mm	Flat	149060007	9311744445899
4-20^	9	4, 6, 8, 10, 12, 14, 16, 18, 20mm	Flat	149060008	9311744445844
4-30^	14	4, 6, 8, 10, 12, 14, 16, 18, 20, 22, 24, 26, 28, 30mm	Flat	149060009	9311744445851
6-36^	11	6, 9, 12, 15, 18, 21, 24, 27, 30, 33, 36mm	Flat	149060010	9311744445868

^New look packaging depicted. Actual product packaging may differ from image shown.

Drills Spade Bits

suttontools

5x faster than standard spade bits.

The Sutton Tools spade bit incorporates the latest design technologies for the most powerful and fastest cutting bit on the market. Combining a power chip-breaker and heavy duty shank to increase efficiency and battery life of your power tool, with clean cutting and minimal break out on exit. Designed for drilling in timber and light building materials.



Spur Cutting Edge
Reduce splintering and ensure a smooth clean hole



Power Chip Breaker Edge
5x faster than standard spade bits



Hex Shank
For positive grip, preventing slippage in chuck

Impact Ready
Suitable for impact drivers and standard power drills

Hole
For hanging in workshop and pulling wires through holes

Heavy Duty Shank
For maximum strength and durability

Application

DIY
Trade
Cabinet Making
Furniture Making
Woodworking

Discount Group: A1302

Diameter mm	Shank Inch	Pieces	Item #	Barcode
Spade Bits				
				D501
6.0	1/4	1	D501 0600	9311963022048
8.0	1/4	1	D501 0800	9311963015545
10.0	1/4	1	D501 1000	9311963012452
12.0	1/4	1	D501 1200	9311963071350
13.0	1/4	1	D501 1300	9311963622316
14.0	1/4	1	D501 1400	9311963071367
16.0	1/4	1	D501 1600	9311963013794
18.0	1/4	1	D501 1800	9311963071374
19.0	1/4	1	D501 1900	9311963013145
20.0	1/4	1	D501 2000	9311963071381
22.0	1/4	1	D501 2200	9311963009155
24.0	1/4	1	D501 2400	9311963071398
25.0	1/4	1	D501 2500	9311963007908
28.0	1/4	1	D501 2800	9311963013800
30.0	1/4	1	D501 3000	9311963071404
32.0	1/4	1	D501 3200	9311963014715
35.0	1/4	1	D501 3500	9311963022055
38.0	1/4	1	D501 3800	9311963022062
Sets				
3 Pce Set	19, 22, 25mm	3	D501 SS3	9311963434087
6 Pce Set	10, 12, 16, 19, 22, 25mm (Vinyl Wallet)	6	D501 SS6W	9311963595016
10 Pce Set	10, 12, 16, 19, 22, 25, 28, 32, 35, 38mm + Bonus 25mm (ABS Case)	10	D501 SS10	9311963622293
Extension Shanks†				D502
150mm	Extension Shank	1	D502 150L	9311963075471
300mm	Extension Shank	1	D502 300L	9311963013817



D502 150L



D501 SS3



D501 SS6W



D501 SS10



Discount Group: A1302

Description	Shank Inch	Pieces	Item #	Barcode
5 Pce Set	12, 16, 18, 20, 25mm	1/4	166044647	9311744446476



166044647

† Suitable for use with Spade Bits 19mm and larger

Drills Auger Bits – 4 Flute

suttontools

Designed for machine and hand drilling into hard and soft wood. Four cutting edges makes cutting up to 5 times faster than standard spade bits.



Hex Shank
For positive grip, preventing slippage in chuck

TCA
Made from Tungsten Chrome Alloy

Coarse Screw Point
Draws the bit into the work piece providing fast drilling in hard and soft woods

Four Cutting Edges
Cuts up to 5 times faster than standard spade bits

Application

- DIY
- Trade
- Electrical
- Plumbing
- Carpentry
- Woodworking
- Roofing

Section Index

Discount Group: A0102

Diameter mm	O/A Length	Flute Length	Shank Inch	Pieces	Item #	Barcode
4 Flute	mm	mm			D514	
10.0	165	42	1/4	1	D514 1000	9311963551715
13.0	165	45	1/4	1	D514 1300	9311963551722
16.0	165	45	1/4	1	D514 1600	9311963551739
19.0	165	45	7/16	1	D514 1900	9311963551746
22.0	165	42	7/16	1	D514 2200	9311963551753
25.0	165	42	7/16	1	D514 2500	9311963551760
32.0	165	45	7/16	1	D514 3200	9311963551777
Sets						
3 Pce Set	16, 19, 25mm			3	D514 0003	9311963551784
5 Pce Set	16, 19, 22, 25, 32mm			5	D514 0005	9311963551791



D514 0003



D514 0005

Drills Auger Bits

suttontools

For fast cutting through holes in timber such as fence posts and railway sleepers. Suitable for kiln dried timber hardwood, softwood, MDF and particle boards. Not suitable for green sap woods.

Section Index

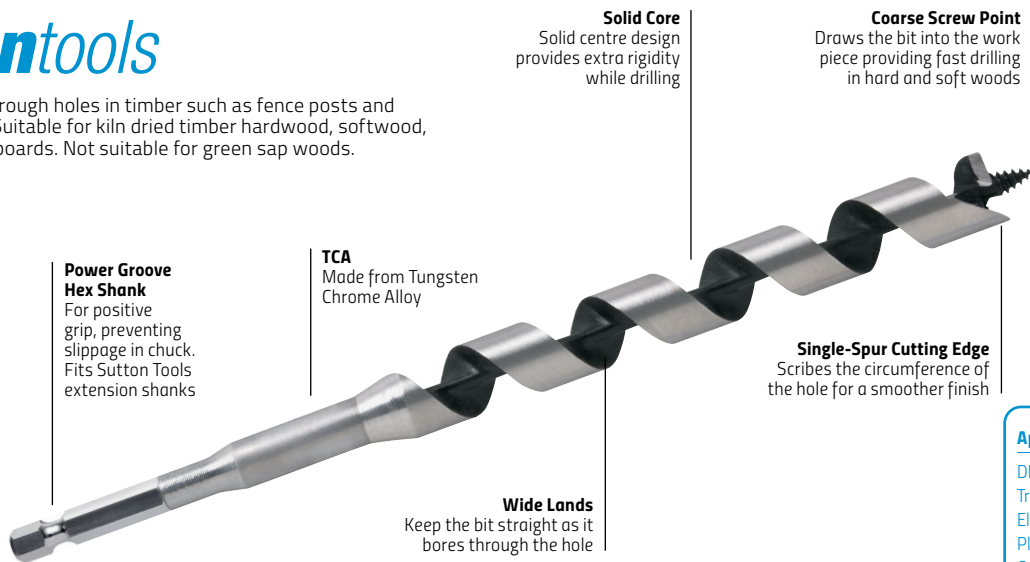

- Application**
- DIY
 - Trade
 - Electrical
 - Plumbing
 - Carpentry
 - Woodworking
 - Roofing

Discount Group: A0102

Diameter mm	O/A Length	Flute Length	Shank Inch	Item #	Barcode
Short Series				D510	
6.0	160	100	1/4	D510 0600	9311963371504
8.0	170	100	1/4	D510 0800	9311963371511
10.0	190	120	1/4	D510 1000	9311963371528
12.0	190	120	1/4	D510 1200	9311963371535
13.0	190	120	7/16	D510 1300	9311963371542
14.0	200	130	7/16	D510 1400	9311963371559
16.0	200	130	7/16	D510 1600	9311963371566
18.0	200	130	7/16	D510 1800	9311963371573
20.0	210	140	7/16	D510 2000	9311963371580
22.0	210	140	7/16	D510 2200	9311963371597
25.0	210	140	7/16	D510 2500	9311963371603
Medium Series				D511	
6.0	230	165	1/4	D511 0600	9311963545363
8.0	225	165	1/4	D511 0800	9311963371610
10.0	250	190	1/4	D511 1000	9311963371627
12.0	270	195	1/4	D511 1200	9311963371634
14.0	290	210	7/16	D511 1400	9311963371641
16.0	290	210	7/16	D511 1600	9311963371658
18.0	330	240	7/16	D511 1800	9311963371665
20.0	330	240	7/16	D511 2000	9311963371672
22.0	330	240	7/16	D511 2200	9311963371689
25.0	330	240	7/16	D511 2500	9311963371696
30.0	330	240	7/16	D511 3000	9311963371702
32.0	330	240	7/16	D511 3200	9311963371719
Long Series				D512	
6.0	460	400	1/4	D512 0600	9311963545370
8.0	460	400	1/4	D512 0800	9311963545387
10.0	500	400	1/4	D512 1000	9311963371733
12.0	500	400	1/4	D512 1200	9311963371740
13.0	500	400	7/16	D512 1300	9311963371757
14.0	500	400	7/16	D512 1400	9311963371764
16.0	500	400	7/16	D512 1600	9311963371771
18.0	500	400	7/16	D512 1800	9311963371788
20.0	500	400	7/16	D512 2000	9311963371795
22.0	500	400	7/16	D512 2200	9311963371801
25.0	500	400	7/16	D512 2500	9311963371818
30.0	500	400	7/16	D512 3000	9311963371825
32.0	500	400	7/16	D512 3200	9311963371832
38.0	500	400	7/16	D512 3800	9311963371856

Drills Auger Bits – Landscape

suttontools

Scotch Pattern auger bits provide more stability and accuracy than standard auger bits making them very suitable for landscape use - in rough, heavily grained or knotted timber. Suitable for boring in hard and soft wood. Also effective for boring in end grain of soft wood, and the end or cross grain of hard wood.

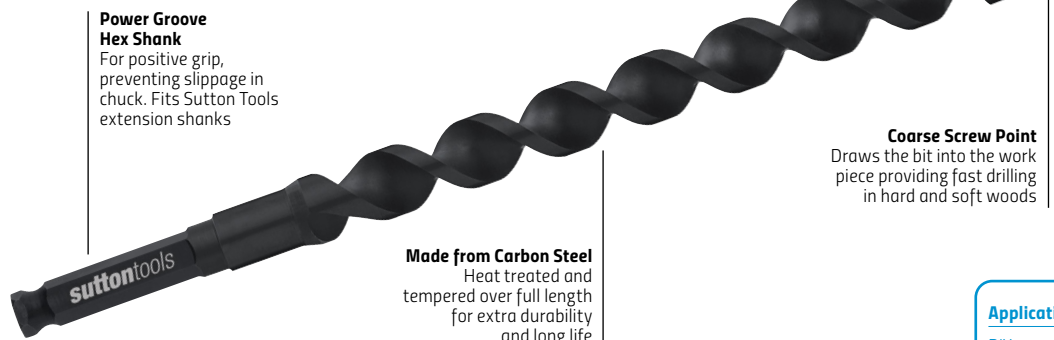

Power Groove Hex Shank
For positive grip, preventing slippage in chuck. Fits Sutton Tools extension shanks

Made from Carbon Steel
Heat treated and tempered over full length for extra durability and long life

Scotch Pattern
Robust scotch pattern flute withstands the hardest wood drilling applications

Coarse Screw Point
Draws the bit into the work piece providing fast drilling in hard and soft woods

Application

DIY
Trade
Landscaping

Discount Group: A0102

Diameter mm	O/A Length	Flute Length	Shank Inch	Item #	Barcode
Landscape Auger	mm	mm			D518
12	300	230	7/16	D518 1200	9311963611228
14	300	230	7/16	D518 1400	9311963611235
16	300	230	7/16	D518 1600	9311963611242
17	300	230	7/16	D518 1700	9311963625577
18	300	230	7/16	D518 1800	9311963611259
19	300	230	7/16	D518 1900	9311963625584
20	300	230	7/16	D518 2000	9311963611266
21	300	230	7/16	D518 2100	9311963625591
22	300	230	7/16	D518 2200	9311963625607
24	300	230	7/16	D518 2400	9311963625614
25	300	230	7/16	D518 2500	9311963625621
28	400	330	7/16	D518 2800	9311963628967
30	400	330	7/16	D518 3000	9311963628974
32	400	330	7/16	D518 3200	9311963628981
38	400	330	7/16	D518 3800	9311963628998

Drills Auger Bits – Garden

suttontools

Transform your power drill to effortlessly dig multiple holes in pliable soil. Suited for planting and installing garden structures quickly. 7/16" hex shanks fits most standard drill chucks or quick change extensions.

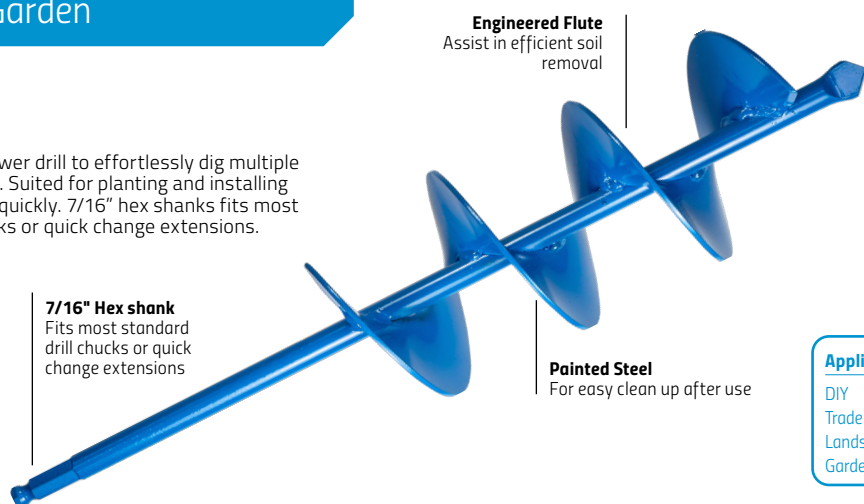

7/16" Hex shank
Fits most standard drill chucks or quick change extensions

Engineered Flute
Assist in efficient soil removal

Painted Steel
For easy clean up after use

Application

DIY
Trade
Landscaping
Gardening

Discount Group: A0102

Diameter mm	O/A Length	Shank Inch	Item #	Barcode
Garden Auger	mm			D520
50	450	7/16	D520 0050	9311963627571
75	450	7/16	D520 0075	9311963627588
100	450	7/16	D520 0100	9311963625867
150	450	7/16	D520 0150	9311963625874
				D522
Garden Auger Adaptor M14	75	7/16	D522 0075	9311963634449



For more info see Adaptors & Attachments section

Drills Forstner Bits

suttontools

For drilling precise flat-bottomed, overlapping or partial holes with smooth sides in wood, MDF or chipboard. 26 and 35mm Forstner bits are suitable for installation of Euro-style hinges.

Rim-guided edge
Can drill into end grain without deflection

Centre point
Ensures an accurate start and prevents wandering

Shank
8mm HCS

Smooth sides and flat bottom finish aids gluing dowels

Application

DIY
Trade
Carpentry

Discount Group: A0102

Diameter mm	O/A Length mm	Shank mm	Pieces	Item #	Barcode
Forstner Bits					
10	90	8	1	D519 0100	9311963621418
12	90	8	1	D519 0120	9311963621425
14	90	8	1	D519 0140	9311963621432
15	90	8	1	D519 0150	9311963621449
16	90	8	1	D519 0160	9311963621456
18	90	8	1	D519 0180	9311963621463
20	90	8	1	D519 0200	9311963621470
22	90	8	1	D519 0220	9311963621487
25	90	8	1	D519 0250	9311963621494
26*	90	8	1	D519 0260	9311963621500
30	90	8	1	D519 0300	9311963621517
35*	90	10	1	D519 0350	9311963621524
Sets					
4 Pce Set	16, 20, 26, 35mm	8	4	D519 0004	9311963621531
12 Pce Set	10, 12, 14, 15, 16, 18, 20, 22, 25, 26, 30, 35mm	10	12	D519 0012	9311963621548



D519 0004



D519 0012



*For Euro-style hinges

Drills Forstner Bits



Designed for the installation of cupboard hinges. These bits are carbide tipped for longer life in cutting abrasive particle board, MDF and timber.

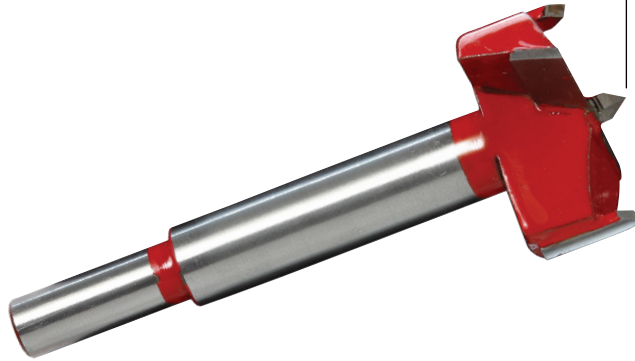

Carbide Tipped
For longer tool life in installation of cupboard hinges

Discount Group: A1302

Diameter mm	O/A Length mm	Shank mm	Item #	Barcode
Forstner Bit	mm			
35	85	8	166044649	9311744446490

Drills Quickbits® - Hinge Mate



Ideal for drilling exact pilot holes in cabinet door hinges and door butts.



Shank
1/4" hex shank suits quick change adaptors



Adjustable Drill Depth

Spring Loaded Outer Guide with Chamfered Head
Makes accurate pilot holes for hinges

Hinge Mate Guide

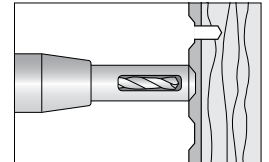

1. The nosepiece bevel centres itself in the hinge's countersink.

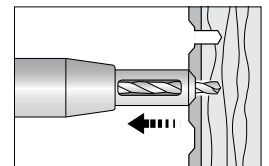

2. Applying pressure causes the nosepiece to retract allowing the bit to drill a perfectly centred pilot hole.

Discount Group: A0424

Inch	Diameter mm	O/A Length mm	Screw Gauge	Shank Inch	Pieces	Item #	Barcode
Hinge Mate		mm					
5/64	1.98	89	3g – 4g	1/4	1	1710781	9311744435821
3/32	2.38	89	5g – 6g	1/4	1	1710937	9311744435838
7/64	2.78	94	5g – 6g	1/4	1	1711094	9311744435845
1/8	3.18	100	8g – 10g	1/4	1	1711250	9311744435852
9/64	3.57	100	8g – 10g	1/4	1	1711406	9311744435869
4 Pce Set	5/64, 7/64, 9/64 & Adaptor			1/4	4	1714000	9311744435890

Drills Brad Points

suttontools

Precision ground brad point drills for use in furniture making, dowelling, cabinetry and other woodworking applications.

Section Index

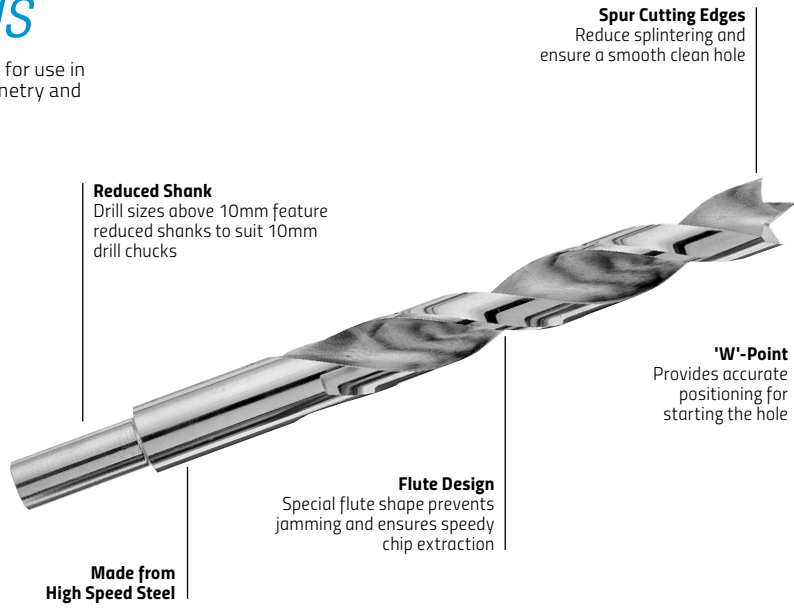

Application

- DIY
- Trade
- Cabinet Making
- Furniture Making
- Woodworking

Discount Group: A1132

Diameter mm	O/A Length	Flute Length	Shank mm	Item #	Barcode
Brad Points	mm	mm			D500
4.0	75	43	4	D500 0400	9311963098340
5.0	86	52	5	D500 0500	9311963098357
6.0	93	57	6	D500 0600	9311963098364
8.0	117	75	8	D500 0800	9311963098371
9.5	125	81	9.5	D500 0950	9311963098388
10.0	133	87	10	D500 1000	9311963098395
12.0	151	101	10	D500 1200	9311963098401

suttontools



**MOST COMPREHENSIVE
MASONRY
DRILL PROGRAM
IN AUSTRALIA AND NEW ZEALAND**

Drills Masonry SDS Plus – 2 Cut

suttontools

Professional quality, 30% faster than conventional SDS drills. For concrete, brick, aerated concrete, stone and granite.



Check out the demo

2 CUT

Patented Destructor Carbide Tip

Aggressive Z-shape self centring point with wavy cutting edges for superior destruction capacity



Sand-blasted Finish
Environmentally friendly production method with zero heavy metals

SDS Plus Shank
Suits ALL SDS Plus rotary hammer drills



Combination Spiral Flute

Half-round spiral accelerates dust extraction away from tip

Square spiral combines compression channel with a depression chamber for perfectly controlled dust removal

Application

- DIY
- Trade
- Professional
- Electrical
- Plumbing
- Carpentry
- Plastering
- Masonry

Discount Group: A0608

Diameter mm	O/A Length	Flute Length	Shank	Item #	Barcode
110mm overall length					
D612					
5.0	110	50	SDS Plus	D612 0500	9311963152189
5.5	110	50	SDS Plus	D612 0550	9311963152196
6.0	110	50	SDS Plus	D612 0600	9311963152202
6.5	110	50	SDS Plus	D612 0650	9311963152219
7.0	110	50	SDS Plus	D612 0700	9311963152226
8.0	110	50	SDS Plus	D612 0800	9311963152233
10.0	110	50	SDS Plus	D612 1000	9311963152257
160mm overall length					
D613					
5.0	160	100	SDS Plus	D613 0500	9311963152264
5.5	160	100	SDS Plus	D613 0550	9311963152271
6.0	160	100	SDS Plus	D613 0600	9311963152288
6.5	160	100	SDS Plus	D613 0650	9311963152295
7.0	160	100	SDS Plus	D613 0700	9311963152301
8.0	160	100	SDS Plus	D613 0800	9311963152318
9.0	160	100	SDS Plus	D613 0900	9311963152325
10.0	160	100	SDS Plus	D613 1000	9311963152332
11.0	160	100	SDS Plus	D613 1100	9311963152339
12.0	160	100	SDS Plus	D613 1200	9311963152346
13.0	160	100	SDS Plus	D613 1300	9311963152353
14.0	160	100	SDS Plus	D613 1400	9311963152360
15.0	160	100	SDS Plus	D613 1500	9311963152367
16.0	160	100	SDS Plus	D613 1600	9311963152374
210mm overall length					
D614					
6.0	210	150	SDS Plus	D614 0600	9311963152400
6.5	210	150	SDS Plus	D614 0650	9311963152417
8.0	210	150	SDS Plus	D614 0800	9311963152431
10.0	210	150	SDS Plus	D614 1000	9311963152455
12.0	210	150	SDS Plus	D614 1200	9311963152479
13.0	210	150	SDS Plus	D614 1300	9311963152486
14.0	210	150	SDS Plus	D614 1400	9311963152493
16.0	210	150	SDS Plus	D614 1600	9311963152516
18.0	210	150	SDS Plus	D614 1800	9311963152523
20.0	210	150	SDS Plus	D614 2000	9311963152530
22.0	210	150	SDS Plus	D614 2200	9311963152521
24.0	210	150	SDS Plus	D614 2400	9311963152526
25.0	210	150	SDS Plus	D614 2500	9311963152533
260mm overall length					
D615					
6.0	260	200	SDS Plus	D615 0600	9311963152540
6.5	260	200	SDS Plus	D615 0650	9311963152527
8.0	260	200	SDS Plus	D615 0800	9311963152564
10.0	260	200	SDS Plus	D615 1000	9311963152592
12.0	260	200	SDS Plus	D615 1200	9311963152615
13.0	260	200	SDS Plus	D615 1300	9311963152622
14.0	260	200	SDS Plus	D615 1400	9311963152639
16.0	260	200	SDS Plus	D615 1600	9311963152653
18.0	260	200	SDS Plus	D615 1800	9311963152711
20.0	260	200	SDS Plus	D615 2000	9311963152684
22.0	260	200	SDS Plus	D615 2200	9311963152691
24.0	260	200	SDS Plus	D615 2400	9311963152707
25.0	260	200	SDS Plus	D615 2500	9311963152714
310mm overall length					
D627					
6.0	310	260	SDS Plus	D627 0600	9311963152888
8.0	310	260	SDS Plus	D627 0800	9311963152955
10.0	310	260	SDS Plus	D627 1000	9311963153011
12.0	310	260	SDS Plus	D627 1200	9311963153181
13.0	310	260	SDS Plus	D627 1300	9311963153235
14.0	310	260	SDS Plus	D627 1400	9311963153332
16.0	310	260	SDS Plus	D627 1600	9311963153449
18.0	310	260	SDS Plus	D627 1800	9311963153556
20.0	310	260	SDS Plus	D627 2000	9311963153663
22.0	310	260	SDS Plus	D627 2200	9311963153770
24.0	310	260	SDS Plus	D627 2400	9311963153877
25.0	310	260	SDS Plus	D627 2500	9311963153984

Diameter mm	O/A Length	Flute Length	Shank	Item #	Barcode
410mm overall length					
D616					
8.0	410	350	SDS Plus	D616 0800	9311963615400
10.0	410	350	SDS Plus	D616 1000	9311963152745
12.0	410	350	SDS Plus	D616 1200	9311963152769
13.0	410	350	SDS Plus	D616 1300	9311963152776
14.0	410	350	SDS Plus	D616 1400	9311963615417
16.0	410	350	SDS Plus	D616 1600	9311963152806
18.0	410	350	SDS Plus	D616 1800	9311963615424
20.0	410	350	SDS Plus	D616 2000	9311963152820
22.0	410	350	SDS Plus	D616 2200	9311963152837
24.0	410	350	SDS Plus	D616 2400	9311963615431
25.0	410	350	SDS Plus	D616 2500	9311963152851
460mm overall length					
D628					
8.0	460	400	SDS Plus	D628 0800	9311963615448
10.0	460	400	SDS Plus	D628 1000	9311963615455
12.0	460	400	SDS Plus	D628 1200	9311963615462
13.0	460	400	SDS Plus	D628 1300	9311963615479
14.0	460	400	SDS Plus	D628 1400	9311963615486
16.0	460	400	SDS Plus	D628 1600	9311963615493
18.0	460	400	SDS Plus	D628 1800	9311963615509
20.0	460	400	SDS Plus	D628 2000	9311963615516
22.0	460	400	SDS Plus	D628 2200	9311963615523
24.0	460	400	SDS Plus	D628 2400	9311963615530
25.0	460	400	SDS Plus	D628 2500	9311963615547
610mm overall length					
D629					
8.0	610	550	SDS Plus	D629 0800	9311963615554
10.0	610	550	SDS Plus	D629 1000	9311963615561
12.0	610	550	SDS Plus	D629 1200	9311963615578
14.0	610	550	SDS Plus	D629 1400	9311963615585
16.0	610	550	SDS Plus	D629 1600	9311963615592
18.0	610	550	SDS Plus	D629 1800	9311963615608
20.0	610	550	SDS Plus	D629 2000	9311963615615
22.0	610	550	SDS Plus	D629 2200	9311963615622
24.0	610	550	SDS Plus	D629 2400	9311963615639
25.0	610	550	SDS Plus	D629 2500	9311963615646
1000mm overall length					
D630					
8.0	1000	940	SDS Plus	D630 0800	9311963615653
10.0	1000	940	SDS Plus	D630 1000	9311963615660
12.0	1000	940	SDS Plus	D630 1200	9311963615677
14.0	1000	940	SDS Plus	D630 1400	9311963615684
16.0	1000	940	SDS Plus	D630 1600	9311963615691
18.0	1000	940	SDS Plus	D630 1800	9311963615707
20.0	1000	940	SDS Plus	D630 2000	9311963615714
Sets					
4 Pce: 6, 8, 10, 12mm	160	100	SDS Plus	D613 0004	9311963591971
7 Pce: 5, 6, 8mm	110	50	SDS Plus	D613 0007	9311963615721
6, 8, 10, 12mm	160	100			
10 Pce Bulk Pack					
5.0	160	100	SDS Plus	D681 0500	9311963627045
5.5	160	100	SDS Plus	D681 0550	9311963627052
6.0	160	100	SDS Plus	D681 0600	9311963627069
6.5	160	100	SDS Plus	D681 0650	9311963627076
8.0	160	100	SDS Plus	D681 0800	9311963627083
10.0	160	100	SDS Plus	D681 1000	9311963627090
12.0	160	100	SDS Plus	D681 1200	9311963627106



The PGM standard (PGM stands for "Prüfgemeinschaft Mauerbohrer" – drill bit testing) is the only guarantee of a perfect geometry for the precise drilling and preferred setting of your anchor studs. It is recommended to use only drill bits with this marking for anchor fixings to prevent accidents and liability cases.

Drills Masonry SDS Plus – 4 Cut

suttontools

Professional quality. For reinforced concrete, brick, aerated concrete, stone and granite.

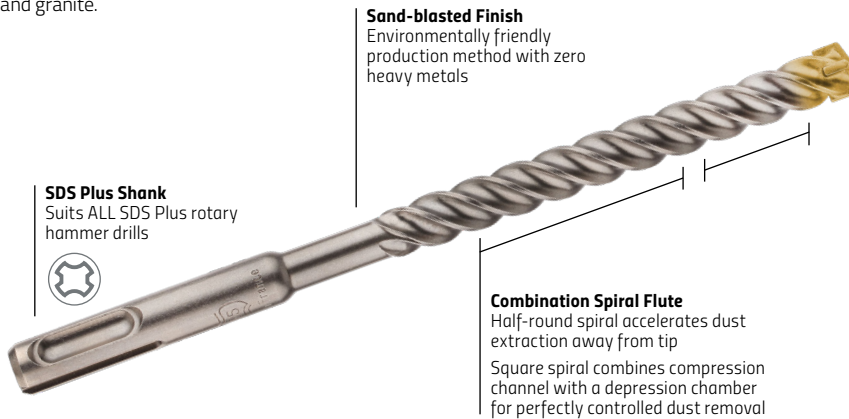

SDS Plus Shank
Suits ALL SDS Plus rotary hammer drills



Sand-blasted Finish
Environmentally friendly production method with zero heavy metals

Combination Spiral Flute
Half-round spiral accelerates dust extraction away from tip
Square spiral combines compression channel with a depression chamber for perfectly controlled dust removal

4 CUT

Unique TCT
4-Cut thin external tips for less friction

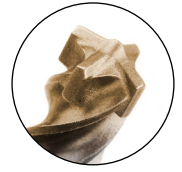

Application

DIY
Trade
Professional
Electrical
Plumbing
Carpentry
Plastering
Masonry

Section
Index

Discount Group: A0608

Diameter mm	O/A Length	Flute Length	Shank	Item #	Barcode
110mm overall length					D631
6.0	110	50	SDS Plus	D631 0600	9311963616476
8.0	110	50	SDS Plus	D631 0800	9311963616490
160mm overall length					D632
5.0	160	100	SDS Plus	D632 0500	9311963616513
6.0	160	100	SDS Plus	D632 0600	9311963616537
6.5	160	100	SDS Plus	D632 0650	9311963616544
8.0	160	100	SDS Plus	D632 0800	9311963616568
10.0	160	100	SDS Plus	D632 1000	9311963616582
12.0	160	100	SDS Plus	D632 1200	9311963616599
210mm overall length					D633
6.0	210	150	SDS Plus	D633 0600	9311963616650
6.5	210	150	SDS Plus	D633 0650	9311963616667
8.0	210	150	SDS Plus	D633 0800	9311963616681
10.0	210	150	SDS Plus	D633 1000	9311963616704
12.0	210	150	SDS Plus	D633 1200	9311963616711
14.0	210	150	SDS Plus	D633 1400	9311963616735
16.0	210	150	SDS Plus	D633 1600	9311963616759
260mm overall length					D634
6.0	260	200	SDS Plus	D634 0600	9311963616797
8.0	260	200	SDS Plus	D634 0800	9311963616827
10.0	260	200	SDS Plus	D634 1000	9311963616834
12.0	260	200	SDS Plus	D634 1200	9311963616858

Diameter mm	O/A Length	Flute Length	Shank	Item #	Barcode
310mm overall length					D635
6.0	310	260	SDS Plus	D635 0600	9311963616964
6.5	310	260	SDS Plus	D635 0650	9311963616971
8.0	310	260	SDS Plus	D635 0800	9311963616988
10.0	310	260	SDS Plus	D635 1000	9311963616995
12.0	310	260	SDS Plus	D635 1200	9311963617008
14.0	310	260	SDS Plus	D635 1400	9311963617022
16.0	310	260	SDS Plus	D635 1600	9311963617039
18.0	310	260	SDS Plus	D635 1800	9311963617046
20.0	310	260	SDS Plus	D635 2000	9311963617053
460mm overall length					D637
10.0	460	400	SDS Plus	D637 1000	9311963617121
12.0	460	400	SDS Plus	D637 1200	9311963617138
14.0	460	400	SDS Plus	D637 1400	9311963617152
16.0	460	400	SDS Plus	D637 1600	9311963617169
20.0	460	400	SDS Plus	D637 2000	9311963617183
10 Pce Bulk Pack					D682
5.0	160	100	SDS Plus	D682 0500	9311963627113
6.0	160	100	SDS Plus	D682 0600	9311963627120
6.5	160	100	SDS Plus	D682 0650	9311963627137
8.0	160	100	SDS Plus	D682 0800	9311963627144
10.0	160	100	SDS Plus	D682 1000	9311963627151
12.0	160	100	SDS Plus	D682 1200	9311963627168
10 Pce Bulk Pack					D683
10.0	210	150	SDS Plus	D683 1000	9311963627175
12.0	210	150	SDS Plus	D683 1200	9311963627182



The PGM standard (PGM stands for "Prüfgemeinschaft Mauerbohrer" – drill bit testing) is the only guarantee of a perfect geometry for the precise drilling and preferred setting of your anchor studs. It is recommended to use only drill bits with this marking for anchor fixings to prevent accidents and liability cases.

Drills Masonry SDS Plus – Reo Pro 3 Cut

suttontools

Professional quality, 30% faster than conventional SDS drills. Will drill through reinforced concrete mesh.



Check out the demo

3 CUT

Unique TCT
Three cutting edge self centring tip prevents snagging on reinforced mesh



Sand-blasted Finish
Environmentally friendly production method with zero heavy metals

SDS Plus Shank
Suits ALL SDS Plus rotary hammer drills



Combination Spiral Flute
Half-round spiral accelerates dust extraction away from tip
Square spiral combines compression channel with a depression chamber for perfectly controlled dust removal



Application

- DIY
- Trade
- Professional
- Electrical
- Plumbing
- Carpentry
- Plastering
- Masonry



Discount Group: A0608

Diameter mm	O/A Length	Flute Length	Shank	Item #	Barcode
110mm overall length SDS Plus				D619	
5.0	110	50	SDS Plus	D619 0500	9311963615745
5.5	110	50	SDS Plus	D619 0550	9311963615752
6.0	110	50	SDS Plus	D619 0600	9311963615769
6.5	110	50	SDS Plus	D619 0650	9311963615776
8.0	110	50	SDS Plus	D619 0800	9311963615783
10.0	110	50	SDS Plus	D619 1000	9311963615790
160mm overall length SDS Plus				D623	
5.0	160	100	SDS Plus	D623 0500	9311963615806
5.5	160	100	SDS Plus	D623 0550	9311963615813
6.0	160	100	SDS Plus	D623 0600	9311963585406
6.5	160	100	SDS Plus	D623 0650	9311963585413
8.0	160	100	SDS Plus	D623 0800	9311963585420
10.0	160	100	SDS Plus	D623 1000	9311963585437
12.0	160	100	SDS Plus	D623 1200	9311963585444
13.0	160	100	SDS Plus	D623 1300	9311963585451
14.0	160	100	SDS Plus	D623 1400	9311963615820
210mm overall length SDS Plus				D624	
6.0	210	150	SDS Plus	D624 0600	9311963585468
6.5	210	150	SDS Plus	D624 0650	9311963585475
8.0	210	150	SDS Plus	D624 0800	9311963585482
10.0	210	150	SDS Plus	D624 1000	9311963585499
12.0	210	150	SDS Plus	D624 1200	9311963585505
13.0	210	150	SDS Plus	D624 1300	9311963585512
14.0	210	150	SDS Plus	D624 1400	9311963585529
16.0	210	150	SDS Plus	D624 1600	9311963585536
18.0	210	150	SDS Plus	D624 1800	9311963585543
20.0	210	150	SDS Plus	D624 2000	9311963615837
310mm overall length SDS Plus				D625	
6.0	310	250	SDS Plus	D625 0600	9311963615844
6.5	310	250	SDS Plus	D625 0650	9311963585550
8.0	310	250	SDS Plus	D625 0800	9311963615851
10.0	310	250	SDS Plus	D625 1000	9311963585567
12.0	310	250	SDS Plus	D625 1200	9311963585574
14.0	310	250	SDS Plus	D625 1400	9311963585581
16.0	310	250	SDS Plus	D625 1600	9311963585598
18.0	310	250	SDS Plus	D625 1800	9311963585604
20.0	310	250	SDS Plus	D625 2000	9311963585611

Diameter mm	O/A Length	Flute Length	Shank	Item #	Barcode
460mm overall length SDS Plus				D626	
8.0	460	400	SDS Plus	D626 0800	9311963615868
10.0	460	400	SDS Plus	D626 1000	9311963615875
12.0	460	400	SDS Plus	D626 1200	9311963615882
14.0	460	400	SDS Plus	D626 1400	9311963615899
16.0	460	400	SDS Plus	D626 1600	9311963585628
18.0	460	400	SDS Plus	D626 1800	9311963615905
20.0	460	400	SDS Plus	D626 2000	9311963585635
Sets SDS Plus				D623	
4 Pce: 6, 8, 10, 12mm				160	100
			SDS Plus	D623 0004	9311963591988
7 Pce: 6, 8, 10, 6, 8, 10, 12				110	50
			SDS Plus	D623 0007	9311963615929



The PGM standard (PGM stands for "Prüfgemeinschaft Mauerbohrer" – drill bit testing) is the only guarantee of a perfect geometry for the precise drilling and preferred setting of your anchor studs. It is recommended to use only drill bits with this marking for anchor fixings to prevent accidents and liability cases.

Drills Masonry SDS Max – Reo Pro 3 Cut

suttontools

Professional quality, 30% faster than conventional SDS drills. Will drill through reinforced concrete mesh.

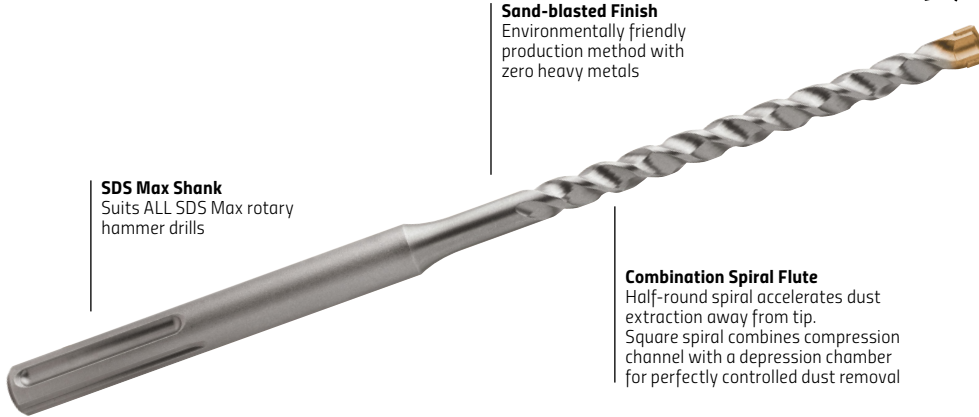

SDS Max Shank
Suits ALL SDS Max rotary hammer drills

Sand-blasted Finish
Environmentally friendly production method with zero heavy metals

Combination Spiral Flute
Half-round spiral accelerates dust extraction away from tip. Square spiral combines compression channel with a depression chamber for perfectly controlled dust removal

Unique TCT Tip
3 cutting edge self centring tip prevents snagging on reinforced mesh

3 CUT



Application

- Trade
- Professional
- Plumbing
- Masonry

Discount Group: A0608

Diameter mm	O/A Length	Flute Length	Shank	Item #	Barcode
340mm overall length				D675	
12.0	340	200	SDS Max	D675 1200	9311963618968
14.0	340	200	SDS Max	D675 1400	9311963618975
16.0	340	200	SDS Max	D675 1600	9311963618982
18.0	340	200	SDS Max	D675 1800	9311963618999
20.0	340	200	SDS Max	D675 2000	9311963619002
540mm overall length				D676	
12.0	540	400	SDS Max	D676 1200	9311963619019
14.0	540	400	SDS Max	D676 1400	9311963619026
16.0	540	400	SDS Max	D676 1600	9311963619033
18.0	540	400	SDS Max	D676 1800	9311963619040
20.0	540	400	SDS Max	D676 2000	9311963619057



The PGM standard (PGM stands for "Prüfgemeinschaft Mauerbohrer" – drill bit testing) is the only guarantee of a perfect geometry for the precise drilling and preferred setting of your anchor studs. It is recommended to use only drill bits with this marking for anchor fixings to prevent accidents and liability cases.

Drills Masonry SDS Max – Reo Extreme 10 Cut

suttontools

100% Carbide head. Superior performance in reinforced concrete. Fits SDS Max drills.



Check out the demo

100% Carbide Head
With 10-Cut head for increase speed and robust performance for 100's holes in reinforced concrete

10 CUT

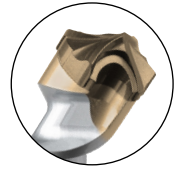

Sand-blasted Finish
Environmentally friendly production method with zero heavy metals

SDS Max Shank
Suits ALL SDS Max rotary hammer drills

Application

- Trade
- Professional
- Plumbing
- Masonry

Discount Group: A0608

Diameter mm	O/A Length	Flute Length	Shank	Item #	Barcode
340mm overall length					
D644					
14.0	340	200	SDS Max	D644 1400	9311963617664
16.0	340	200	SDS Max	D644 1600	9311963617688
18.0	340	200	SDS Max	D644 1800	9311963617695
20.0	340	200	SDS Max	D644 2000	9311963617718
22.0	340	200	SDS Max	D644 2200	9311963617725
24.0	340	200	SDS Max	D644 2400	9311963617732
25.0	340	200	SDS Max	D644 2500	9311963617749
26.0	340	200	SDS Max	D644 2600	9311963617756
28.0	340	200	SDS Max	D644 2800	9311963617763
30.0	340	200	SDS Max	D644 3000	9311963617770
32.0	340	200	SDS Max	D644 3200	9311963617787
36.0	340	200	SDS Max	D644 3600	9311963617800
38.0	340	200	SDS Max	D644 3800	9311963617817
40.0	340	200	SDS Max	D644 4000	9311963617824
42.0	340	200	SDS Max	D644 4200	9311963617831
45.0	340	200	SDS Max	D644 4500	9311963617848
540mm overall length					
D645					
16.0	540	400	SDS Max	D645 1600	9311963617886
18.0	540	400	SDS Max	D645 1800	9311963617893
20.0	540	400	SDS Max	D645 2000	9311963617916
22.0	540	400	SDS Max	D645 2200	9311963617923
24.0	540	400	SDS Max	D645 2400	9311963617930
25.0	540	400	SDS Max	D645 2500	9311963617947
26.0	540	400	SDS Max	D645 2600	9311963617954
28.0	540	400	SDS Max	D645 2800	9311963617961
30.0	540	400	SDS Max	D645 3000	9311963617985
32.0	540	400	SDS Max	D645 3200	9311963617992
36.0	540	400	SDS Max	D645 3600	9311963618012
38.0	540	400	SDS Max	D645 3800	9311963618029
40.0	540	400	SDS Max	D645 4000	9311963618036
42.0	540	400	SDS Max	D645 4200	9311963618043
45.0	540	400	SDS Max	D645 4500	9311963618050
690mm overall length					
D646					
16.0	690	550	SDS Max	D646 1600	9311963618067
18.0	690	550	SDS Max	D646 1800	9311963618074
20.0	690	550	SDS Max	D646 2000	9311963618098
22.0	690	550	SDS Max	D646 2200	9311963618104
24.0	690	550	SDS Max	D646 2400	9311963618111
25.0	690	550	SDS Max	D646 2500	9311963618128
26.0	690	550	SDS Max	D646 2600	9311963618135
28.0	690	550	SDS Max	D646 2800	9311963618142
30.0	690	550	SDS Max	D646 3000	9311963618159
32.0	690	550	SDS Max	D646 3200	9311963618166
36.0	690	550	SDS Max	D646 3600	9311963618180
38.0	690	550	SDS Max	D646 3800	9311963618197
40.0	690	550	SDS Max	D646 4000	9311963618203
42.0	690	550	SDS Max	D646 4200	9311963618210
45.0	690	550	SDS Max	D646 4500	9311963618227

Diameter mm	O/A Length	Flute Length	Shank	Item #	Barcode
920mm overall length					
D647					
16.0	920	780	SDS Max	D647 1600	9311963618234
18.0	920	780	SDS Max	D647 1800	9311963618241
20.0	920	780	SDS Max	D647 2000	9311963618258
22.0	920	780	SDS Max	D647 2200	9311963618265
24.0	920	780	SDS Max	D647 2400	9311963618272
25.0	920	780	SDS Max	D647 2500	9311963618289
28.0	920	780	SDS Max	D647 2800	9311963618302
30.0	920	780	SDS Max	D647 3000	9311963618326
32.0	920	780	SDS Max	D647 3200	9311963618333
36.0	920	780	SDS Max	D647 3600	9311963618357
40.0	920	780	SDS Max	D647 4000	9311963618364
1300mm overall length					
D648					
20.0	1300	1160	SDS Max	D648 2000	9311963618395
22.0	1300	1160	SDS Max	D648 2200	9311963618401
25.0	1300	1160	SDS Max	D648 2500	9311963618418
28.0	1300	1160	SDS Max	D648 2800	9311963618425
32.0	1300	1160	SDS Max	D648 3200	9311963618432
36.0	1300	1160	SDS Max	D648 3600	9311963618456
1500mm overall length					
D649					
20.0	1500	1360	SDS Max	D649 2000	9311963618487
24.0	1500	1360	SDS Max	D649 2400	9311963618494
25.0	1500	1360	SDS Max	D649 2500	9311963618500
28.0	1500	1360	SDS Max	D649 2800	9311963618517
32.0	1500	1360	SDS Max	D649 3200	9311963618524
36.0	1500	1360	SDS Max	D649 3600	9311963618531
40.0	1500	1360	SDS Max	D649 4000	9311963618548

Drills Masonry SDS Max – Speeduster 10 Cut

suttontools

Designed for clean and fast drilling with its 10 cutters, 100% carbide massive head system. Wide extraction holes allows immediate dust extraction with an attached vacuum via the connecting sleeves.

The dust extraction also allows faster drilling due to minimal blockage during drilling and can significantly extend tool life. For heavy duty drilling in reinforced concrete, concrete, granite, stone and bricks.



Check out the demo

Section
Index

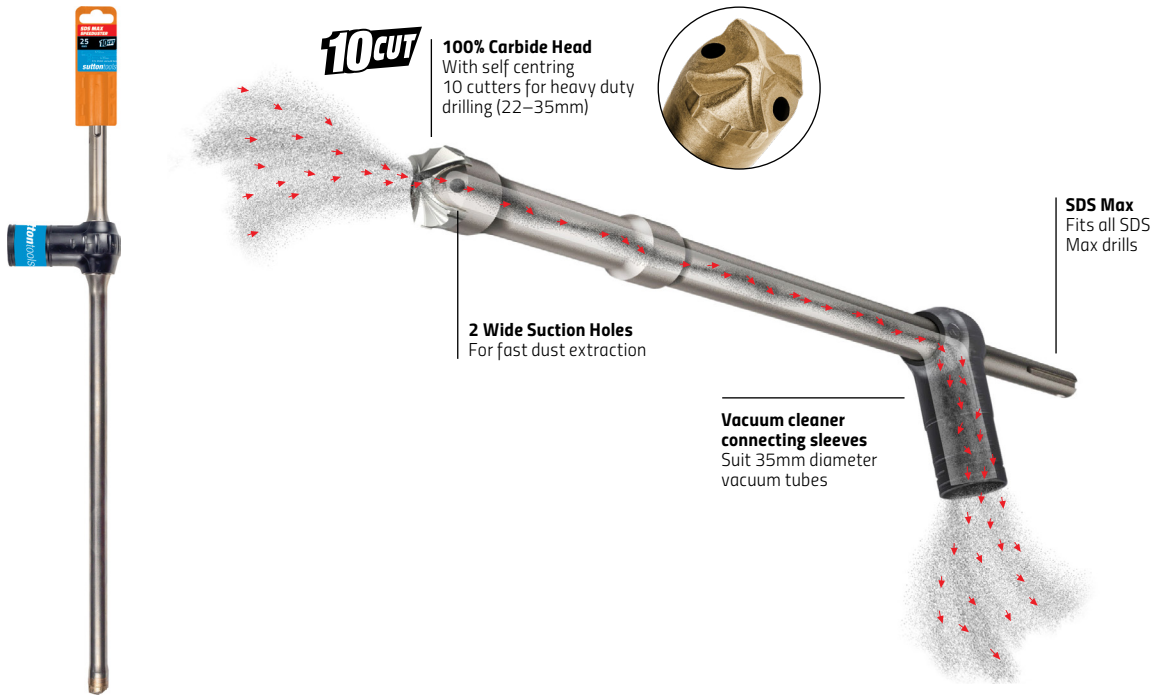

Application

- Trade
- Professional
- Plumbing
- Masonry

Discount Group: A0608

Diameter mm	O/A Length	Flute Length	Item #	Barcode
Speeduster	mm	mm		D640
14*	610	400	D640 0140	9311963623443
16*	610	400	D640 0160	9311963623450
18*	610	400	D640 0180	9311963623467
20*	610	400	D640 0200	9311963623474
22	610	400	D640 0220	9311963623481
25	610	400	D640 0250	9311963623498
28	610	400	D640 0280	9311963623504
30	610	400	D640 0300	9311963623511
32	610	400	D640 0320	9311963623528
35	610	400	D640 0350	9311963623535
Collector & Seal			D640 0001	9311963623542

*Equipped with 3-Cut TCT Tip.

Drilling Comparison

Standard SDS
Max Drill



Dust pile



**SPEEDUSTER
SDS MAX**



Clean holes



Drills Masonry SDS Plus – 2 Cut Clean Breakout

suttontools

Professional quality, 30% faster than conventional SDS drills. For concrete, brick, aerated concrete, stone and granite. Specially made for drilling through hollow bricks, with a clean finish without degrading walls.

130° Tungsten Carbide Tip
Semi-Positive tungsten carbide tip facilitates penetration and limits the contact with the material during the drilling

2 CUT

3X STRONGER
Up to 3 times stronger resistance

SDS Plus Shank
Suits ALL SDS Plus rotary hammer drills

Clean Break Out
Drills clean holes which improves the reliability of anchoring

Application

- DIY
- Trade
- Professional
- Electrical
- Plumbing
- Carpentry
- Plastering
- Masonry

Discount Group: A0608

Diameter mm	O/A Length	Flute Length	Shank	Item #	Barcode
160mm overall length				D684	
5.0	160	75	SDS Plus	D684 0500	9311963629025
6.0	160	75	SDS Plus	D684 0600	9311963629032
8.0	160	75	SDS Plus	D684 0800	9311963629049
10.0	160	75	SDS Plus	D684 1000	9311963629056
260mm overall length				D685	
6.0	260	140	SDS Plus	D685 0600	9311963629063
8.0	260	140	SDS Plus	D685 0800	9311963629070
10.0	260	140	SDS Plus	D685 1000	9311963629087
12.0	260	140	SDS Plus	D685 1200	9311963629094
14.0	260	140	SDS Plus	D685 1400	9311963629100
16.0	260	140	SDS Plus	D685 1600	9311963629117

Comparative Test: Drilling & Anchoring in Hollow Brick

Standard Drill



Damaged hole

Drilling

The wall is damaged, only 7mm thickness remains

Test of tearing for a chemical fixing

The fixation quickly gives in. Break in 250kg.

2 Cut Clean Breakout



Clean hole

Drilling

The wall is intact and keeps its original thickness of 16mm.

Test of tearing for a chemical fixing

The fixation resists perfectly, it is the wall which gives in. Break in 700kg.

Drills Masonry SDS Plus – Stop Drills

suttontools

Sutton Tools Stop Drills are perfect for use with drop in anchors. Featuring an integrated depth stop to accurately control the required drilling depth allowing fast, high-volume installation. Key applications include suspended electrical and ventilation systems, fixed-location seating and bollards.

Suitable for all types of concrete, brick, aerated concrete, stone and granite. Will drill through reinforced concrete mesh.

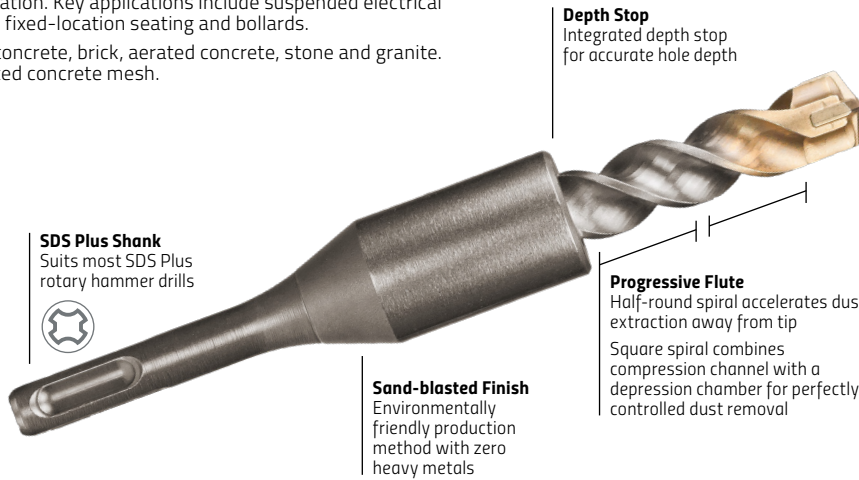

SDS Plus Shank
Suits most SDS Plus rotary hammer drills



Sand-blasted Finish
Environmentally friendly production method with zero heavy metals

Depth Stop
Integrated depth stop for accurate hole depth

Progressive Flute
Half-round spiral accelerates dust extraction away from tip
Square spiral combines compression channel with a depression chamber for perfectly controlled dust removal

Three Cutting Edge
135° self centring tip with three cutting edges guarantees a perfectly round hole



Application

Trade
Professional
Electrical
Plumbing
Masonry

Discount Group: A0608

Diameter mm	O/A Length	Flute Length	Shank	Suits Anchor	Item #	Barcode
Stop Drill	mm	mm				D617
8.0	110	27	SDS Plus	M6x25	D617 0800	9311963611280
10.0	110	32	SDS Plus	M8x30	D617 1000	9311963611297
12.0	130	42	SDS Plus	M10x40	D617 1200	9311963611303
15.0	160	52	SDS Plus	M12x50	D617 1500	9311963611310

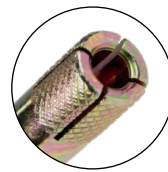

Perfect for drop-in anchors

M6x25
M8x30
M10x40
M12x50



The PGM standard (PGM stands for "Prüfgemeinschaft Mauerbohrer" – drill bit testing) is the only guarantee of a perfect geometry for the precise drilling and preferred setting of your anchor studs. It is recommended to use only drill bits with this marking for anchor fixings to prevent accidents and liability cases.

Core Bits SDS Plus

Light duty for electrical equipment and door frames. Core Bits drill bricks, limestone and Concrete panel. For rotary hammer drills not exceeding 700W.



Tungsten Carbide Teeth
Welded at high temperature for stronger cutting performance

40mm Cut Depth
For light duty application

Discount Group: A0608

Diameter mm	Cut Depth	O/A Length	Shank	Item #	Barcode
Masonry Hammer Carbide Core Bits (Light Duty)				D657*	
25.0	40	60	SDS Plus	D657 0250	9311963616087
30.0	40	60	SDS Plus	D657 0300	9311963616094
35.0	40	60	SDS Plus	D657 0350	9311963616100
40.0	40	60	SDS Plus	D657 0400	9311963616117
45.0	40	60	SDS Plus	D657 0450	9311963616124
50.0	40	60	SDS Plus	D657 0500	9311963616131
60.0	40	60	SDS Plus	D657 0600	9311963616148
66.0	40	60	SDS Plus	D657 0660	9311963616155
68.0	40	60	SDS Plus	D657 0680	9311963616162
70.0	40	60	SDS Plus	D657 0700	9311963616179
80.0	40	60	SDS Plus	D657 0800	9311963616186
90.0	40	60	SDS Plus	D657 0900	9311963616193
Masonry Adaptor (including Pilot Drill)				D658*	
		90	SDS Plus	D658 0900	9311963616209
		150	SDS Plus	D658 1500	9311963616216
		200	SDS Plus	D658 2000	9311963616223
		300	SDS Plus	D658 3000	9311963616230
		135	Hex	D659 1350	9311963616261

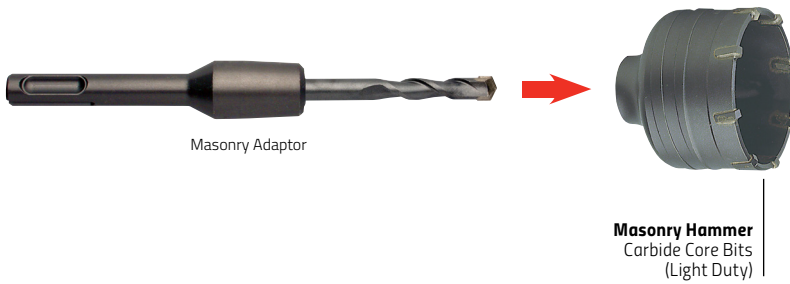

Note: Core bits and adaptors sold separately
*Not available once current stock is depleted



Core Bits SDS Max

Heavy duty taper crown carbide core bit for building, plumbing and restoration work. For all types of hammer drills over 900W.



Tungsten Carbide Teeth
Welded at high temperature for stronger cutting performance

75mm Cut Depth
Deeper depths for heavy duty application



Discount Group: A0608

Diameter mm	Cut Depth	O/A Length	Shank	Item #	Barcode
Taper Crown Hammer Carbide Core Bits (Heavy Duty)					
30.0	75	100	SDS Max	D655 0300	9311963615936
35.0	75	100	SDS Max	D655 0350	9311963615943
40.0	75	100	SDS Max	D655 0400	9311963615950
45.0	75	100	SDS Max	D655 0450	9311963615967
50.0	75	100	SDS Max	D655 0500	9311963615974
60.0	75	100	SDS Max	D655 0600	9311963615981
66.0	75	100	SDS Max	D655 0660	9311963615998
70.0	75	100	SDS Max	D655 0700	9311963616001
80.0	75	100	SDS Max	D655 0800	9311963616018
90.0	75	100	SDS Max	D655 0900	9311963616025
100.0	75	100	SDS Max	D655 1000	9311963616032
110.0	75	100	SDS Max	D655 1100	9311963616049
125.0	75	100	SDS Max	D655 1250	9311963616056
Crown Adaptor (Excluding Pilot Drill)					
		220	SDS Max	D659 2200	9311963616247
		420	SDS Max	D659 4200	9311963616254
Pilot Drill					
	90	120		D656 0002	9311963616063
Drift Key					
				D656 0003	9311963616070

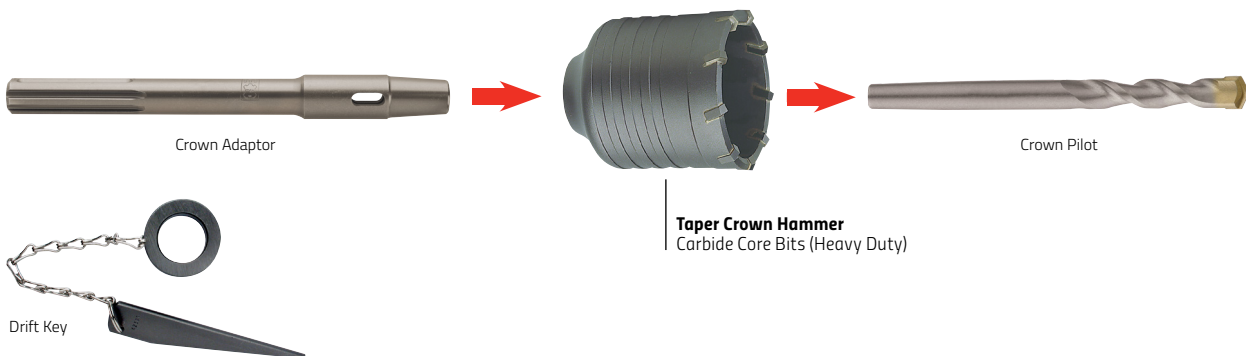

*Not available once current stock is depleted

suttontools

Sand-blasted Finish

Environmentally friendly production method with zero heavy metals. Made from high tensile steel. Specially toughened steel and optimum cutter geometry ensure long life and fast, efficient work.

Profile
Available in:
Pointed
Flat
Angle Head
Toothed
Toothed
Brick Chasing
Concrete Chasing

Sand-blasted Finish
Environmentally friendly production method with zero heavy metals

Shank
Suits SDS Plus and SDS Max rotary hammer drills

Application

- Demolition
- DIY
- Trade
- Electrical
- Plumbing
- Carpentry
- Plastering
- General Contracting
- Masonry
- Renovation

Discount Group: A0608

Type	Width mm	O/A Length mm	Shank	Item #	Barcode
SDS-Plus					
Pointed	14.0	250	SDS Plus	D660 1425	9311963616278
					D660
Flat	20.0	250	SDS Plus	D661 2025	9311963616285
	40.0	200	SDS Plus	D661 4020	9311963616292
					D661
Angled	40.0	200	SDS Plus	D662 4020	9311963616308
					D662
Concrete Chasing	22.0	250	SDS Plus	D663 2225	9311963616315
					D663
SDS-Max					
Pointed	18.0	280	SDS Max	D670 1828	9311963616322
	18.0	400	SDS Max	D670 1840	9311963616339
	18.0	600	SDS Max	D670 1860	9311963616346
					D670
Flat	24.0	280	SDS Max	D671 2428	9311963616353
	24.0	400	SDS Max	D671 2440	9311963616384
	24.0	600	SDS Max	D671 2460	9311963616391
	50.0	360	SDS Max	D671 5036	9311963616360
	80.0	300	SDS Max	D671 8030	9311963616377
	115.0	350	SDS Max	D671 1153	9311963616407
					D671
Angled	50.0	300	SDS Max	D672 5030	9311963616414
					D672
Brick Chasing	35.0	380	SDS Max	D673 3538	9311963616438
Concrete Chasing	26.0	300	SDS Max	D673 2625	9311963616421
					D673
Toothed	40.0	280	SDS Max	D674 4028	9311963616445
					D674



Pointed (Helical)
Targeted chiselling and breaking work.



Flat
For general purpose chiselling and breaking work.

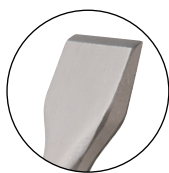

Angle Head
For easy removal of tiles.



Toothed
Tungsten carbide tipped for repointing, removing bricks, tiles and plaster.

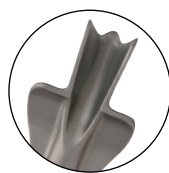

Brick Chasing
Ideal for cabling and plumbing applications.



Concrete Chasing
For cutting narrow channels.

Chisels SDS Plus



Tradesman Quality

SDS Plus Chisels, forged from toughened steel to ensure long life and fast, efficient work.

Profile
Available in
Pointed or Flat



Shank
Suits SDS Plus rotary
hammer drills

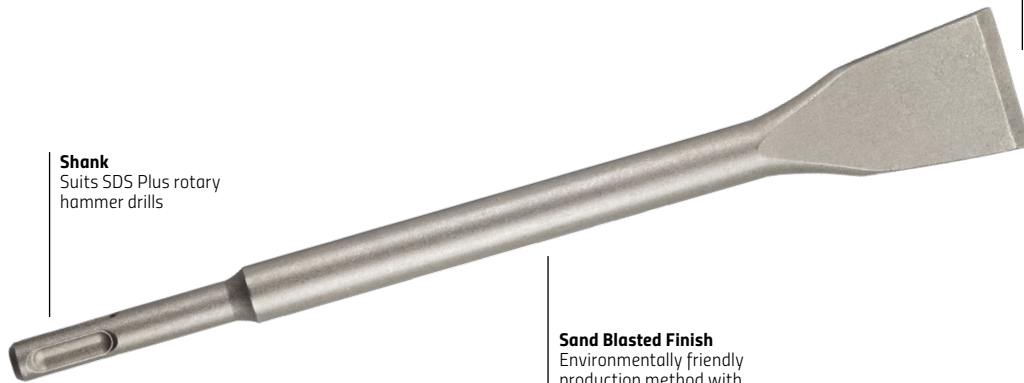

Sand Blasted Finish
Environmentally friendly
production method with
zero heavy metals

Application

- Demolition
- DIY
- Trade
- Electrical
- Plumbing
- Carpentry
- Plastering
- General Contracting
- Masonry
- Renovation

Discount Group: A0608

Type	Width mm	O/A Length mm	Shank	Item #	Barcode
Pointed	14.0	250	SDS Plus	165115014	9311744443284
Flat	25.0	250	SDS Plus	165117025	9311744442379
Flat	40.0	250	SDS Plus	165117040	9311744442386



165115014

165117025

165117040



Pointed (Helical)

Targeted chiselling
and breaking work

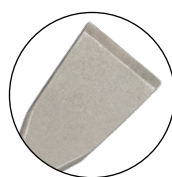

Flat

For general purpose
chiselling and breaking work

^New look packaging depicted. Actual product packaging may differ from image shown.

suttontools

Tradesman quality ideal for use in natural and artificial stone, masonry, brickwork and concrete.

TCT Point
Two cutting edged carbide percussion tip with semi positive profile for aggressive drilling in hard materials

Brazed Tip
Unique brazing process ensures a perfect bond between tip and body

Parallel Shank
For rotary hammer and percussion drilling

Double Spiral Flute
Rolled double flute, provides greater dust extraction, extending drill life

Application

DIY
Trade
Electrical
Plumbing
Carpentry
Plastering
Masonry

Discount Group: A0604

Diameter mm	O/A Length	Shank mm	Plug Colour	Item #	Barcode
Standard Fixing				D600	
3.0	60		☀ Yellow	D600 0300	93220705
4.0	75			D600 0400	93220712
5.0	85		☉ White	D600 0500	93220729
5.5	95		☄ Red	D600 0550	93220736
6.0	100			D600 0600	93220743
6.5	100		☀ Green	D600 0650	93220750
7.0	100			D600 0700	93220767
8.0	120		☀ Blue	D600 0800	93220774
9.0	120			D600 0900	93220781
10.0	120		☀ Orange	D600 1000	93220798
12.0	120	10		D600 1200	93220811
13.0	120	10		D600 1300	93220828
Single Brick				D601	
5.0	150		☉ White	D601 0500	93220835
5.5	150		☄ Red	D601 0550	93220842
6.0	150			D601 0600	93220859
6.5	150		☀ Green	D601 0650	93220866
7.0	150			D601 0700	93220873
8.0	150		☀ Blue	D601 0800	93220880
10.0	150		☀ Orange	D601 1000	93220897
11.0	150	10	☉ Grey	D601 1100	93220903
12.0	150	10		D601 1200	93220910
13.0	150	10		D601 1300	93220927
14.0	150	10		D601 1400	93220934
16.0	150	12.7	☉ Black	D601 1600	93220941
20.0	160	12.7		D601 2000	93221337
22.0	160	12.7		D601 2200	93221344
25.0	160	12.7		D601 2500	93221351
Double Brick				D602	
6.5	400			D602 0650	9311963003740
8.0	400			D602 0800	9311963005539
10.0	400			D602 1000	9311963003177
13.0	400	10		D602 1300	9311963003948
16.0	400	12.7		D602 1600	9311963004716
20.0	400	12.7		D602 2000	9311963008288
22.0	400	12.7		D602 2200	9311963010823
25.0	400	12.7		D602 2500	9311963009179

Discount Group: A0604/A1202

Sets	Contents	Pieces	Item #	Barcode
Masonry	(SF): 4.0, 5.0, 5.5, 6.5, 8.0, 10.0mm	6	D600 SMD2	9311963080055
Combination	D600 Masonry Drill Bits: 5.5, 6.0, 6.5, 8.0mm D105 Viper Drill Bits: 1.5, 2.0, 3.0, 4.0, 5.0mm	9	D600 0009	9311963335049



D600 SMD2

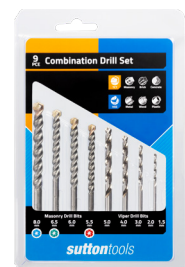

D600 0009

(SF) – Standard Fixing (SB) – Single Brick (DB) – Double Brick

Drills Masonry – Bulk Pack

suttontools

Tradesman quality ideal for use in natural and artificial stone, masonry, brickwork and concrete.

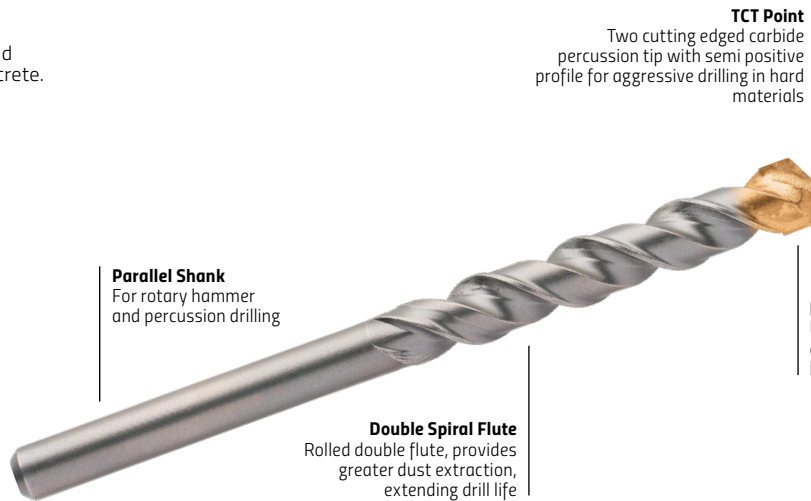

Parallel Shank
For rotary hammer and percussion drilling

Double Spiral Flute
Rolled double flute, provides greater dust extraction, extending drill life

TCT Point
Two cutting edged carbide percussion tip with semi positive profile for aggressive drilling in hard materials

Brazed Tip
Unique brazing process ensures a perfect bond between tip and body

Discount Group: A0604

Diameter mm	O/A Length	Plug Colour	Pieces	Item #	Barcode
Standard Fixing				D650	
5.0	85	White	5	D650 0500	9311963631776
6.0	100		5	D650 0600	9311963631783
6.5	100	Green	5	D650 0650	9311963631790
8.0	120	Blue	5	D650 0800	9311963631806
10.0	120	Orange	5	D650 1000	9311963631813
Set	5.0, 6.0, 6.5, 8.0, 10.0mm		5	D650 0005	9311963631769
Single Brick				D651	
5.0	150	White	5	D651 0500	9311963631837
6.0	150		5	D651 0600	9311963631844
6.5	150	Green	5	D651 0650	9311963631851
8.0	150	Blue	5	D651 0800	9311963631868
10.0	150	Orange	5	D651 1000	9311963631875
Set	5.0, 6.0, 6.5, 8.0, 10.0mm		5	D651 0005	9311963631820

Drills Masonry – Hammer Hex, Anti-Slip

suttontools

Professional quality for tougher masonry applications. Combining excellent power transfer and efficiency. For concrete, brick, aerated concrete, hollow brick and plaster block.

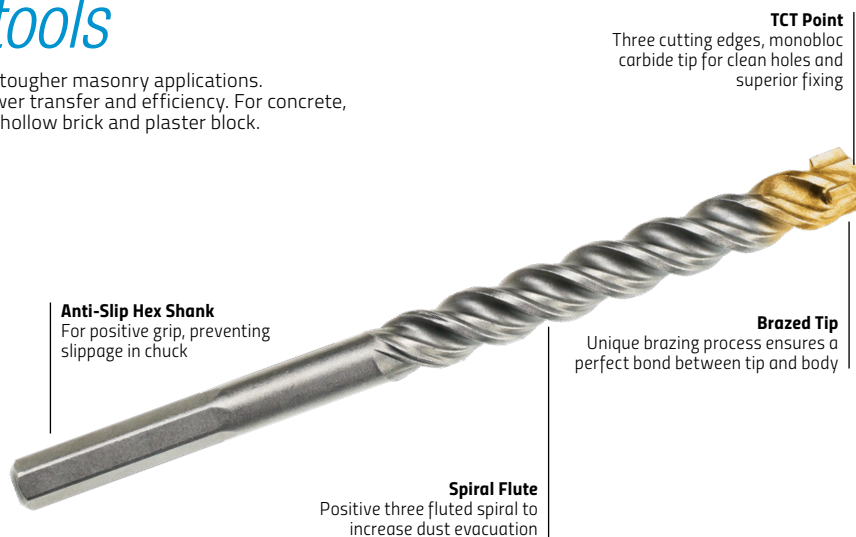

Anti-Slip Hex Shank
For positive grip, preventing slippage in chuck

Spiral Flute
Positive three fluted spiral to increase dust evacuation

TCT Point
Three cutting edges, monobloc carbide tip for clean holes and superior fixing

Brazed Tip
Unique brazing process ensures a perfect bond between tip and body

Application

DIY
Trade
Electrical
Plumbing
Carpentry
Plastering
Masonry

Discount Group: A0608

Diameter mm	O/A Length	Shank	Plug Colour	Item #	Barcode
Hammer Hex				D606	
5.0	150	Hex	White	D606 0500	9311963551432
6.0	150	Hex	Red	D606 0600	9311963551449
6.5	150	Hex	Green	D606 0650	9311963551456
8.0	150	Hex	Blue	D606 0800	9311963551463
10.0	150	Hex	Orange	D606 1000	9311963551470
12.0	150	Hex	Grey	D606 1200	9311963551487
13.0	150	Hex		D606 1300	9311963551494

Drills Masonry – Impact

suttontools



Supabits are developed for use with the high torque output of an impact driver. Suitable for use in natural and artificial stone, brickwork, concrete and masonry materials.

Positively sharpened
Carbide tip with 2 cutting edges

Section Index

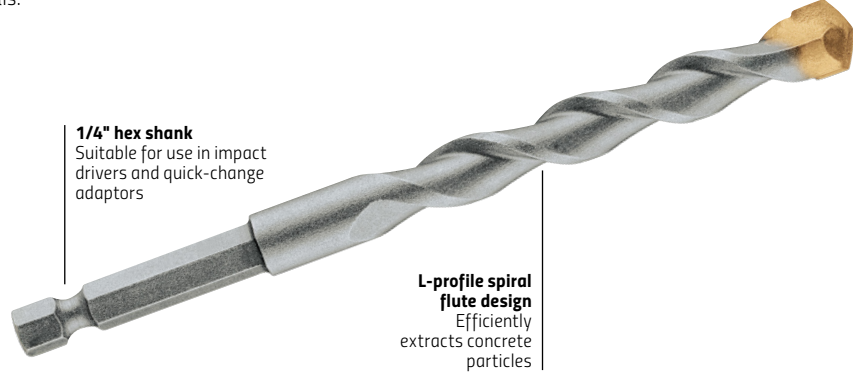

1/4" hex shank
Suitable for use in impact drivers and quick-change adaptors

L-profile spiral flute design
Efficiently extracts concrete particles

Application
DIY
Trade
Electrical
Plumbing
Carpentry
Plastering
Masonry

Discount Group: A0608

Diameter mm	O/A Length	Flute Length	Shank Inch	Plug Colour	Item #	Barcode
Supabit	mm	mm				D609
3.0	80	30	1/4	☀️ Yellow	D609 0300	9311963600697
4.0	90	40	1/4		D609 0400	9311963600703
5.0	100	40	1/4	⚙️ White	D609 0500	9311963600710
6.0	110	65	1/4	🔴 Red	D609 0600	9311963600727
6.5	110	65	1/4	🟢 Green	D609 0650	9311963604404
8.0	120	70	1/4	🟡 Blue	D609 0800	9311963600734
10.0	120	73	1/4	🟠 Orange	D609 1000	9311963600741

Drills Masonry – DIY Range



DIY quality for use in general masonry applications.

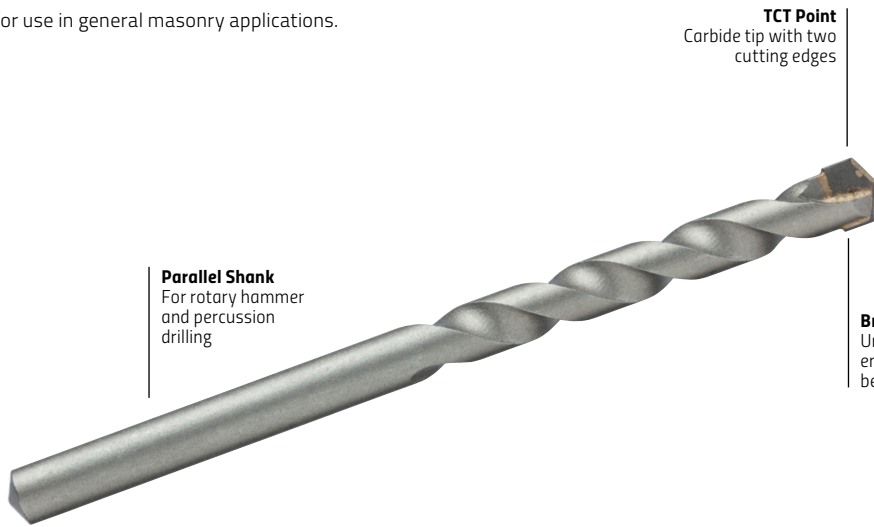

TCT Point
Carbide tip with two cutting edges

Parallel Shank
For rotary hammer and percussion drilling

Brazed Tip
Unique brazing process ensures a perfect bond between tip and body

Application

- DIY
- Trade
- Electrical
- Plumbing
- Carpentry
- Plastering
- Masonry

Description	Pieces	Item #	Barcode
Masonry Drill Set (Discount Group: A0604)			
4, 5, 6, 8, 9, 10, 12mm	7	166044644	9311744446445
SDS Plus Masonry Drill & Chisel Set (Discount Group: A0608)			
12 Masonry Drills: 5, 6, 8, 10 x 110mm; 6, 8, 10, 12 x 160mm; 8, 10, x 210mm; 10, 12 x 260mm 3 Flat Chisels: 20 x 140mm; 20 x 250mm; 40 x 250mm & 2 Point Chisels: 14 x 140mm; 14 x 250mm	17	166044643	9311744446438



166044644



166044643

Drills Multi-Purpose

suttontools

For drilling in various materials such as timber, concrete, brick, stainless steel, cast iron, steel and glass. Especially suited for drilling multi-laminated construction materials.

Hammer Action: For masonry materials only.*
Rotary Action: For all other materials.

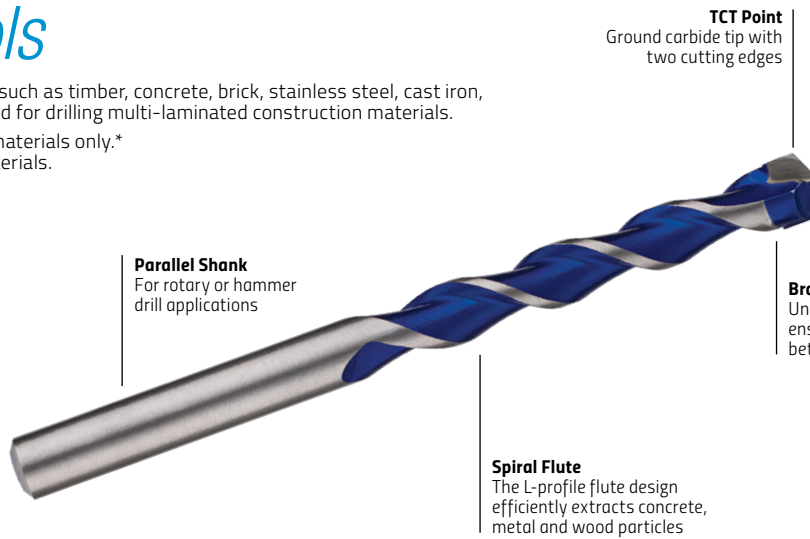

TCT Point
Ground carbide tip with two cutting edges

Parallel Shank
For rotary or hammer drill applications

Spiral Flute
The L-profile flute design efficiently extracts concrete, metal and wood particles

Brazed Tip
Unique brazing process ensures a perfect bond between tip and body

Application

DIY
Trade
Electrical
Plumbing
Carpentry
Plastering
Masonry

Discount Group: A0604

Diameter mm	O/A Length	Plug Colour	Item #	Barcode
Standard Length			D610	
3.0	60	Yellow	D610 0300	9311963432502
4.0	75		D610 0400	9311963432519
5.0	85	White	D610 0500	9311963432526
5.5	85	Red	D610 0550	9311963432533
6.0	100		D610 0600	9311963432540
6.5	100	Green	D610 0650	9311963432557
7.0	100		D610 0700	9311963432564
8.0	120	Blue	D610 0800	9311963432571
9.0	120		D610 0900	9311963432588
10.0	120	Orange	D610 1000	9311963432595
12.0	150		D610 1200	9311963432649
13.0	150		D610 1300	9311963432847
14.0	150		D610 1400	9311963432656
15.0	150		D610 1500	9311963432854
16.0	150	Black	D610 1600	9311963432861
Extra Length			D611	
6.5	300	Green	D611 0653	9311963432878
7.0	300		D611 0703	9311963432885
8.0	300	Blue	D611 0803	9311963432663
10.0	300	Orange	D611 1003	9311963432670
12.0	300		D611 1203	9311963432687
13.0	300		D611 1303	9311963432892

*Drilling masonry materials prior to wood or steel will dull tip reducing the cutting performance.

Drills Glass & Tile

suttontools

For smooth drilling in ceramic tiles, glass, brick, plastics, and fibreglass.
 Note: Not suitable for toughened glass and hard tiles above class 3.

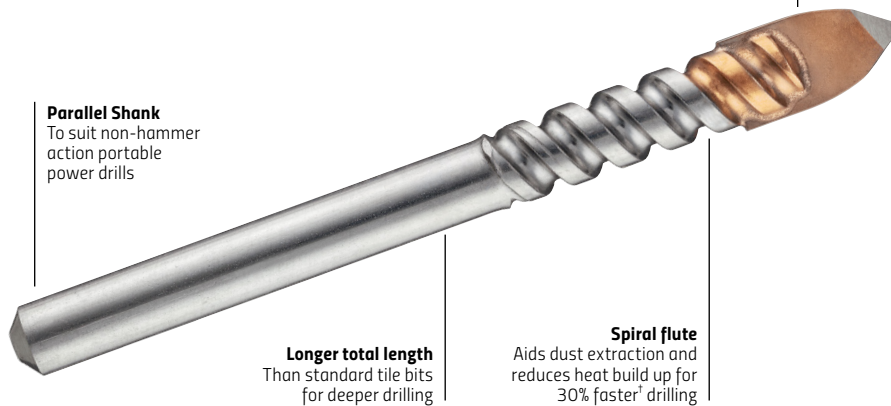
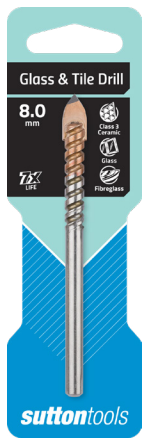

Parallel Shank
 To suit non-hammer action portable power drills

Longer total length
 Than standard tile bits for deeper drilling

Spiral flute
 Aids dust extraction and reduces heat build up for 30% faster[†] drilling

Stronger carbide tip
 With copper brazing has better heat resistance and provides 7x longer life[†]

4 facet diamond spear point design
 Shaves rather than cuts for improved precision and penetration

Application

DIY
 Trade
 Plumbing
 Masonry

Discount Group: A0606

Diameter mm	O/A Length	Item #	Barcode
Glass & Tile Drill	mm	D604	
3.0	80	D604 0300	9311963169668
4.0	80	D604 0400	9311963169675
5.0	80	D604 0500	9311963169743
6.0	80	D604 0600	9311963169699
6.5	100	D604 0650	9311963411187
8.0	100	D604 0800	9311963169712
10.0	100	D604 1000	9311963169729
12.0	100	D604 1200	9311963169736

[†]Than standard glass and tile drills.

Core Bits Diamond – Dry Cut

Trade quality for dry cutting in porcelain, monocottura and fully vitrified, marble, glazed, terracotta, polished sandstone, standard ceramic and sandstone tiles.



10mm hex shank
 For positive grip, preventing slippage in chucks

Special wax filled core
 Aids cooling and provides cleaner job site

Vacuum brazed #40 diamond grit tip
 For thermal and mechanical strength

Application

DIY
 Trade
 Plumbing
 Masonry

Discount Group: A0608

Diameter mm	Drilling Depth	O/A Length	Shank	Pieces	Item #	Barcode
Diamond Core Bit	mm	mm			D618	
6	10	67	10mm Hex	1	D618 0600	9311963611334
8	10	80	10mm Hex	1	D618 0800	9311963611341
10	10	80	10mm Hex	1	D618 1000	9311963611358
Set						
4 Pce Set: 6, 8, 10mm with Guide				4	D618 0004	9311963611426

Core Bits Diamond – Blue Ceram

suttontools



Features diamond segment technology for long life, using with water.

For drilling porcelain, monocottura, marble, glazed, terracotta, sandstone and standard ceramic tiles.

Point

Diamond segment tip for long life. Can be dressed for optimal performance



Check out the demo



Shank

10mm hex shank to suit non-hammer action portable power drills

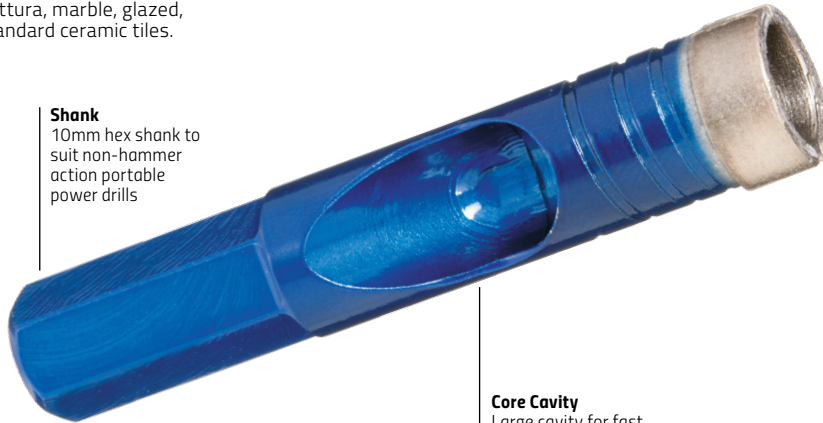

Core Cavity

Large cavity for fast material extraction

Application

- DIY
- Trade
- Plumbing
- Masonry

Discount Group: A0609

Diameter mm	Actual Hole Diameter*	Drilling Depth	O/A Length	Shank	Item #	Barcode
Diamond Core Bit	mm	mm	mm			D605
6.0	6.3	8	55	10mm Hex	D605 0600	9311963509914
7.0	7.4	8	55	10mm Hex	D605 0700	9311963509921
8.0	8.4	10	55	10mm Hex	D605 0800	9311963509938
10.0	10.6	15	65	10mm Hex	D605 1000	9311963509945
12.0	12.6	15	65	10mm Hex	D605 1200	9311963509952
15.0	15.6	15	70	10mm Hex	D605 1500	9311963509969
20.0	20.6	15	70	10mm Hex	D605 2000	9311963509976
25.0	25.6	15	70	10mm Hex	D605 2500	9311963509983
Dressing Stone					D605 ST01	9311963509990
Water Dripper (5-15mm)					D605 WAT2	9311963556574
Water Dripper (20-25mm)					D605 WAT3	9311963556581

*Blue Ceram drills oversize to allow drilling and fixing into material below the surface without chipping the tile.

Instructions For Use



Water the drilling area. To avoid drill slipping start with a 45° angle.



After the hole is started gradually straighten up the drill.



Make a swinging movement to allow for dust evacuation.



Make sure the core has been removed from bit after drilling.



When tip darkens, it is becoming blunt and MUST be dressed using a dressing stone.



Helpful Hints

- Do not use with hammer setting as this will damage the bit and tile
- Apply consistent pressure, allowing the tool to do the work
- Cutting speed with water <3000 RPM
- Dressing the bit will increase performance

Water Dripper



D605 WAT2

Core Bits Diamond



DIY Quality. Diamond Tile Core bits have diamond encrusting for wet drilling only. For drilling glazed and polished porcelain, sandstone, terracotta and ceramics.

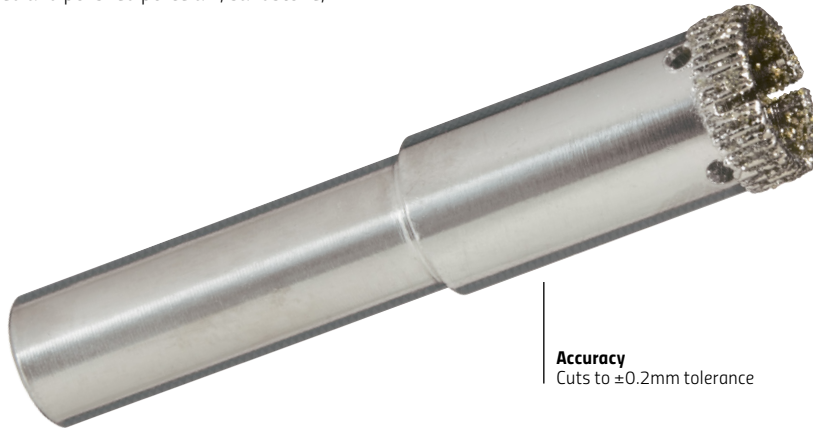

Point
Diamond encrusted tip to cut through glazed and polished porcelain, sandstone, terracotta and ceramics

Accuracy
Cuts to ± 0.2 mm tolerance

Application
DIY
Trade
Plumbing
Masonry

Discount Group: A0609

Diameter mm	Drilling Depth	O/A Length	Shank mm	Pieces	Item #	Barcode
Diamond Core Bit	mm	mm				
6.0	6	55	10	1	148010006	9311744435104
8.0	6	55	10	1	148010008	9311744435111
10.0	6	55	10	1	148010010	9311744435128
12.0	6	55	10	1	148010012	9311744436811
15.0	6	55	10	1	148010015	9311744436828
20.0	6	55	10	1	148010020	9311744436835
25.0	6	55	10	1	148010025	9311744436842
30.0	6	55	10	1	148010030	9311744439256
32.0	6	55	10	1	148010032	9311744439263
35.0	6	55	10	1	148010035	9311744439270
40.0	6	55	10	1	148010040	9311744439287
50.0	6	55	10	1	148010050	9311744439294
55.0	6	55	10	1	148010055	9311744439300
65.0	6	55	10	1	148010065	9311744439317
75.0	6	55	10	1	148010075	9311744439324
Set						
6 Pce Set	6, 8, 10, 12, 15mm			6	148010706	9311744439805



148010706

Shanks

Parallel / Plain Shank



The straight shank is the most usual style on modern drill bits, by number manufactured. It is most often made with the same diameter as the drill bit, for economy. It's then held in a 3-jaw drill chuck. Very small bits can have straight shanks larger than the drill diameter, often for holding in a standard size collet. Large drill bits can have straight shanks smaller than their drill diameter, so that medium-size chucks can be used to drill large holes. Such a drill bit is called reduced-shank or a blacksmith's drill.

- Can be held in a collet chuck
- Can be held in a drill chuck, the commonest sort
- Very accurate centring
- Low torque transmission

Hex shank



The flats of a hex shank can either be machined on a round shank or can be the natural flats of hex bar stock. A hex shank can be grasped by a 3-jaw drill chuck, or can be held in a custom chuck specifically for hex shanks. 1/4 inch hex shanks are common for machine screwdriver bits, and have spread from that application to be used for drill bits that are compatible with screwdriver machinery.

- Can be held in a drill chuck
- Can be held in a screwdriver bit chuck
- High torque transmission
- Moderately accurate centring
- Cannot be held in a collet

SDS shank



The SDS shank has the advantage of a simple spring-loaded chuck, so that bits can be chucked with a simple and quick hand action. Further, the shank and chuck are uniquely suited to hammer drilling in stone and concrete. The drill bit is not held solidly in the chuck, but can slide back and forth like a piston. The hammer of the drill acts to accelerate only the drill bit itself, and not the large mass of the chuck, which makes hammer drilling with an SDS shank drill bit much more productive than with other types of shank. So, SDS shanks are most often seen on masonry drills for which hammer drilling action is most helpful.

SDS is available in four sizes, SDS, SDS plus (or SDS-plus or SDS+), SDS-Top and SDS-max. SDS-plus is the most common by count of tools manufactured, with masonry drills from 5mm diameter to 30mm diameter ordinarily available.

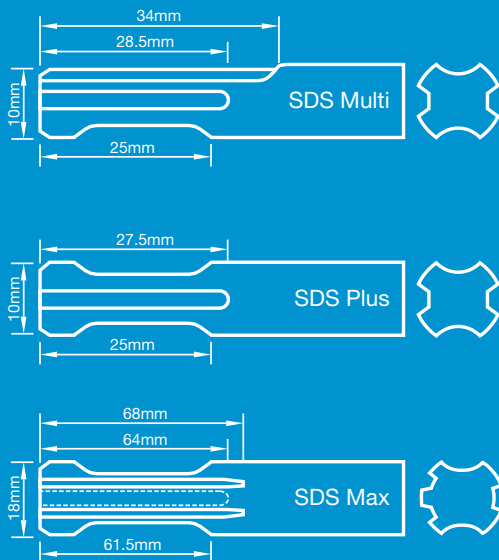

The SDS bit was developed in 1975 and the name comes from the German saying "Steck – Dreh – Sitz" (Insert – Twist – Stay).

German-speaking countries may use "Spannen Durch System" (Clamping System), though most use "Special Direct System" for international purposes.

- Superb hammer drilling performance
- Drills with a "rotation-stop" mode can use chiselling bits
- One-handed quick chucking operation
- Can only be held in an SDS chuck
- High torque transmission

The flute (spiral) with a long pitch (lead) permits a quick removal of the aggregates (dust). The new finishing (treatment) "sandblasted" strengthens the body of the drill in the surface while guaranteeing good flexibility. Ideal for soft and medium hard materials and for wet concrete. The shank is suitable for all SDS plus hammer drilling machines.

Environmental Statement

Sutton Tools masonry drills are certified ISO 14001 for sustainable development. These products contribute to environmental protection by a "sandblasted" surface treatment which guarantees zero heavy metals and by a protection called "without VOC (Volatile Organic Compounds)" meeting the European directive 1999/13CE.