

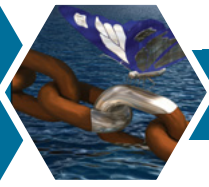

# STAINLESS HARDWARE









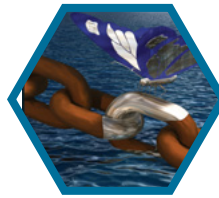





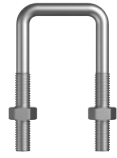
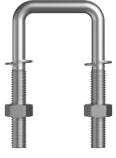





# STAINLESS HARDWARE

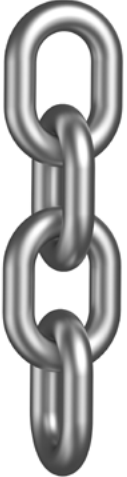

<p><b>D SHACKLE STANDARD</b></p> <p>316</p>  <p><b>HSH16DSM</b></p> <p>316 STAINLESS STEEL A4</p>	<p><b>D SHACKLE CAPTIVE PIN</b></p> <p>316</p>  <p><b>HSH16CPM</b></p> <p>316 STAINLESS STEEL A4</p>	<p><b>D SHACKLE LONG</b></p> <p>316</p>  <p><b>HSH16LGM</b></p> <p>316 STAINLESS STEEL A4</p>	<p><b>D SHACKLE LIGHTWEIGHT</b></p> <p>304</p>  <p><b>HSH04LWM</b></p> <p>304 STAINLESS STEEL A2</p>	<p><b>D SHACKLE INTERNAL HEX PIN</b></p> <p>316</p>  <p><b>HSH16HPM</b></p> <p>316 STAINLESS STEEL A4</p>	<p><b>D SHACKLE WIDE MOUTH</b></p> <p>316</p>  <p><b>HSH16WMM</b></p> <p>316 STAINLESS STEEL A4</p>	<p><b>D SHACKLE BOW</b></p> <p>316</p>  <p><b>HSH16BWM</b></p> <p>316 STAINLESS STEEL A4</p>
<p><b>SHACKLE TWISTED</b></p> <p>316</p>  <p><b>HSH16TWM</b></p> <p>316 STAINLESS STEEL A4</p>	<p><b>D SHACKLE DOUBLE BAR</b></p> <p>316</p>  <p><b>HSH16DBM</b></p> <p>316 STAINLESS STEEL A4</p>	<p><b>SHACKLE REPLACEMENT PIN</b></p> <p>316</p>  <p><b>HXPINS</b></p> <p>316 STAINLESS STEEL A4</p>	<p><b>SWIVEL EYE + SNAP</b></p> <p>316</p>  <p><b>HSW16EP</b></p> <p>316 STAINLESS STEEL A4</p>	<p><b>SWIVEL EYE + EYE</b></p> <p>316</p>  <p><b>HSW16EE</b></p> <p>316 STAINLESS STEEL A4</p>	<p><b>SWIVEL JAW + JAW</b></p> <p>316</p>  <p><b>HSW16JJ</b></p> <p>316 STAINLESS STEEL A4</p>	<p><b>SWIVEL EYE + SNAP SHACKLE</b></p> <p>316</p>  <p><b>HSW16EK</b></p> <p>316 STAINLESS STEEL A4</p>
<p><b>SWIVEL JAW + SNAP SHACKLE</b></p> <p>316</p>  <p><b>HSW16JK</b></p> <p>316 STAINLESS STEEL A4</p>	<p><b>S HOOK</b></p> <p>304</p>  <p><b>HHK04S</b></p> <p>304 STAINLESS STEEL A2</p>	<p><b>SNAP HOOK CAST</b></p> <p>316</p>  <p><b>HHK16CP</b></p> <p>316 STAINLESS STEEL A4</p>	<p><b>SPRING HOOK ASYMMETRIC</b></p> <p>316</p>  <p><b>HHK16SA</b></p> <p>316 STAINLESS STEEL A4</p>	<p><b>SNAP HOOK SAFETY LATCH</b></p> <p>316</p>  <p><b>HHK16CL</b></p> <p>316 STAINLESS STEEL A4</p>	<p><b>SNAP HOOK RIGID EYE</b></p> <p>316</p>  <p><b>HHK16CR</b></p> <p>316 STAINLESS STEEL A4</p>	<p><b>SPRING HOOK</b></p> <p>316</p>  <p><b>HHK16SP</b></p> <p>316 STAINLESS STEEL A4</p>
<p><b>SPRING HOOK EYE</b></p> <p>316</p>  <p><b>HHK16SE</b></p> <p>316 STAINLESS STEEL A4</p>	<p><b>SPRING HOOK EYE &amp; NUT</b></p> <p>316</p>  <p><b>HHK16SN</b></p> <p>316 STAINLESS STEEL A4</p>	<p><b>PELICAN HOOK</b></p> <p>316</p>  <p><b>HHK16PEM</b></p> <p>316 STAINLESS STEEL A4</p>	<p><b>PAD EYE DIAMOND</b></p> <p>304</p>  <p><b>HEP04DI</b></p> <p>304 STAINLESS STEEL A2</p>	<p><b>PAD EYE OVAL</b></p> <p>304</p>  <p><b>HEP04OV</b></p> <p>304 STAINLESS STEEL A2</p>	<p><b>PAD EYE OBLONG</b></p> <p>304</p>  <p><b>HEP04OB</b></p> <p>304 STAINLESS STEEL A2</p>	<p><b>PAD EYE OBLONG &amp; RING</b></p> <p>304</p>  <p><b>HEP04OR</b></p> <p>304 STAINLESS STEEL A2</p>



<p><b>PAD EYE ROUND BOLT</b></p> <p>304</p>  <p><b>HEP04RB</b></p> <p>304 STAINLESS STEEL A2</p>	<p><b>PAD EYE ROUND</b></p> <p>304</p>  <p><b>HEP04RD</b></p> <p>304 STAINLESS STEEL A2</p>	<p><b>PAD EYE ROUND OPEN</b></p> <p>304</p>  <p><b>HEP04RO</b></p> <p>304 STAINLESS STEEL A2</p>	<p><b>U BOLT KIT ROUND</b></p> <p>316</p>  <p><b>KUR16PCM</b></p> <p>316 STAINLESS STEEL A4</p>	<p><b>U BOLT KIT + PLATE &amp; CRIMP</b></p> <p>304</p>  <p><b>HUR04KPM</b></p> <p>304 STAINLESS STEEL A2</p>	<p><b>U BOLT KIT SQUARE</b></p> <p>316</p>  <p><b>KUS16PCM</b></p> <p>316 STAINLESS STEEL A4</p>	<p><b>U BOLT KIT SQUARE WITH SPRING WASHER</b></p> <p>316</p>  <p><b>KUS16PSM</b></p> <p>316 STAINLESS STEEL A4</p>
<p><b>CHAIN LINK CLIP POLISHED</b></p> <p>316</p>  <p><b>HCH16LC</b></p> <p>316 STAINLESS STEEL A4</p>	<p><b>CHAIN LINK QUIK POLISHED</b></p> <p>316</p>  <p><b>HCH16LQ</b></p> <p>316 STAINLESS STEEL A4</p>	<p><b>WELDED RING DEE</b></p> <p>304</p>  <p><b>HRG04WD</b></p> <p>304 STAINLESS STEEL A2</p>				
<p><b>EYE BOLT KIT COLLAR</b></p> <p>316</p>  <p><b>HEC16KM</b></p> <p>316 STAINLESS STEEL A4</p>	<p><b>LAG SCREW EYE COLLAR</b></p> <p>316</p>  <p><b>HES16CL</b></p> <p>316 STAINLESS STEEL A4</p>	<p><b>EYE BOLT KIT</b></p> <p>304</p>  <p><b>HEB04PM</b></p> <p>304 STAINLESS STEEL A2</p>	<p><b>WELDED RING TRIANGLE</b></p> <p>304</p>  <p><b>HRG04WT</b></p> <p>304 STAINLESS STEEL A2</p>	<p><b>WELDED RING ROUND</b></p> <p>304</p>  <p><b>HRG04WR</b></p> <p>304 STAINLESS STEEL A2</p>	<p><b>WELDED RING ROUND</b></p> <p>316</p>  <p><b>HRG16WR</b></p> <p>316 STAINLESS STEEL A4</p>	<p><b>CHAIN LINK REGULAR POLISHED</b></p> <p>316</p>  <p><b>HCH16LP</b></p> <p>316 STAINLESS STEEL A4</p>
			<p><b>EYE NUT COLLAR</b></p> <p>316</p>  <p><b>HEN16PM</b></p> <p>316 STAINLESS STEEL A4</p>	<p><b>EYE BOLT COLLAR</b></p> <p>316</p>  <p><b>HEC16PM</b></p> <p>316 STAINLESS STEEL A4</p>	<p><b>NEW EYE NUT COLLAR</b></p> <p>316</p>  <p><b>HEN16P5M</b></p> <p>316 STAINLESS STEEL HEC 582 / A4</p>	



## PIANO HINGE DRILLED

304



**HHP04D**

304  
STAINLESS STEEL  
A2

## PIANO HINGE UNDRILLED

304



**HHP04U**

304  
STAINLESS STEEL  
A2

## 304 STAINLESS STEEL

# HINGES

Use with  
countersunk screws  
for flush finish.

**DRILLX**

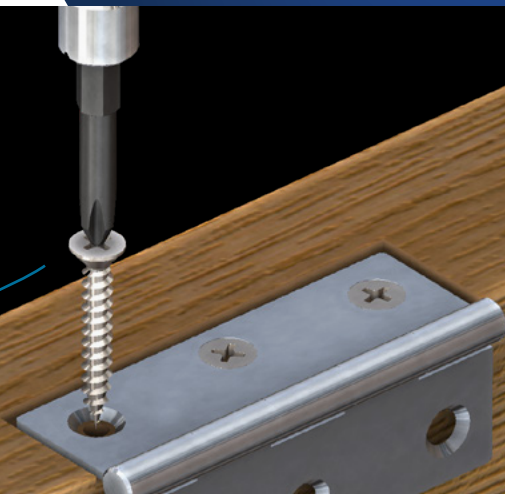

## BUTT HINGE 4 HOLE FIXED PIN

304



**HHB04D-050**

304  
STAINLESS STEEL  
A2

## BUTT HINGE 6 HOLE FIXED PIN

304



**HHB04D-075**

304  
STAINLESS STEEL  
A2

## BUTT HINGE 8 HOLE FIXED PIN

304



**HHB04D-100**

304  
STAINLESS STEEL  
A2

## NEW BUTT HINGE 8 HOLE LOOSE PIN

304



**HHB04L**

304  
STAINLESS STEEL  
A2

## FLUSH FITTING HINGE

304



**HHF04D-100**

304  
STAINLESS STEEL  
A2

## FLUSH FITTING HINGE

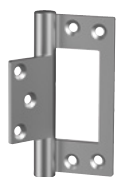

**HHFALD-100**

ALUMINIUM  
HEC

## HATCH HINGE EVEN

304



**HHH04E**

304  
STAINLESS STEEL  
A2

## HATCH HINGE UNEVEN

304



**HHH04U**

304  
STAINLESS STEEL  
A2

## HATCH HINGE EVEN

316



**HHH16E**

316  
STAINLESS STEEL  
A4

## HATCH HINGE UNEVEN

316



**HHH16U**

316  
STAINLESS STEEL  
A4

## TOGGLE LATCH ADJUSTABLE

304

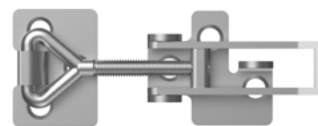

**HLT04A**

304  
STAINLESS STEEL  
A2

## MULTI-GRIP

316



**HGM16D**

316  
STAINLESS STEEL  
A4

## TRIPLE-GRIP LEFT HAND

316



**HGT16L**

316  
STAINLESS STEEL  
A4

## TRIPLE-GRIP RIGHT HAND

316



**HGT16R**

316  
STAINLESS STEEL  
A4

## JOIST HANGER

316

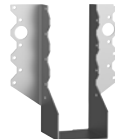

**HHJ16D**

316  
STAINLESS STEEL  
A4

## Joist Hanger

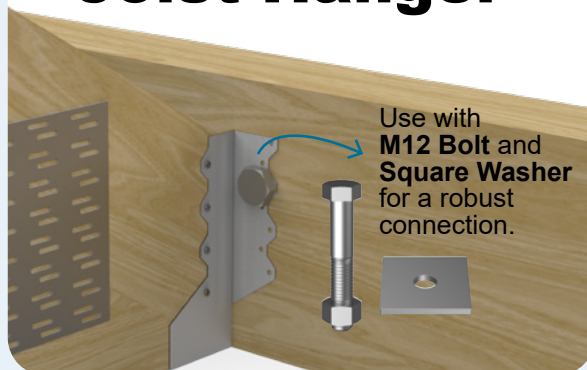

Use with  
M12 Bolt and  
Square Washer  
for a robust  
connection.



**WIRE ROPE**  
7x19  
FLEXIBLE

316

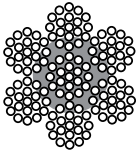

HRW16719

316  
STAINLESS STEEL  
A4

**WIRE ROPE**  
7x7  
WORKABLE

316

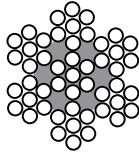

HRW16707

316  
STAINLESS STEEL  
A4

**WIRE ROPE**  
7x7 PVC  
COATED

316

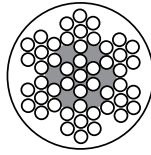

HRW16707P

316  
STAINLESS STEEL  
A4

**WIRE ROPE**  
1x19  
RIGID

316

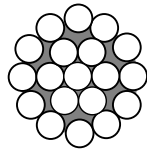

HRW16119

316  
STAINLESS STEEL  
A4

316



## Wire Rope

- » 3.2mm
- » 305m per roll
- » 100m and 1000m rolls also available

**WIRE ROPE CUTTER**



HTHRC-008

TOOL HAND  
CUT up to 5.0  
WIRE ROPE

**WIRE ROPE CUTTER**



HTHRC-450

TOOL HAND  
CUT up to 12.0  
WIRE ROPE

**WIRE ROPE CUTTER**



HTHRC-800

TOOL HAND  
CUT up to 16.0  
WIRE ROPE

**CUTTING AND SWAGING COMBO**



HTHSC-350

TOOL HAND  
CUT up to 3.5  
WIRE ROPE

**CUTTING AND SWAGING COMBO**



HTHSC-600

TOOL HAND  
CUT up to 5.0  
WIRE ROPE

## Cutting Tool

- » Designed for cutting wire rope and piano steel wire
- » Comfortable rubber grip handles
- » Shear cut blades give a clean sharp cut

## Swaging Tool

- » Designed for swaging or crimping copper or aluminium swages.
- » Forged alloy steel heat-treated jaws designed to produce a tight clean compression of copper and aluminium swages.





304 & 316 STAINLESS STEEL

# BALUSTRADE

Imagine. Create. Transform.

Check out our wide range of Balustrade Solutions at [hobson.com.au](http://hobson.com.au)



<p><b>TERMINAL SWAGE FORK</b></p> <p>316</p>  <p><b>HTS16FK</b></p> <p>316 STAINLESS STEEL A4</p>	<p><b>TERMINAL SWAGE FORK MINI TYPE</b></p> <p>316</p>  <p><b>HTS16FM</b></p> <p>316 STAINLESS STEEL A4</p>	<p><b>TERMINAL SWAGE FORK TOGGLE</b></p> <p>316</p>  <p><b>HTS16FT</b></p> <p>316 STAINLESS STEEL A4</p>	<p><b>TERMINAL SWAGE STUD MINI</b></p> <p>316</p>  <p><b>HTS16MT</b></p> <p>316 STAINLESS STEEL A4</p>	<p><b>TERMINAL SWAGE EYE</b></p> <p>316</p>  <p><b>HTS16EY</b></p> <p>316 STAINLESS STEEL A4</p>	<p><b>TERMINAL SWAGE BUTTON HEAD</b></p> <p>316</p>  <p><b>HTS16BH</b></p> <p>316 STAINLESS STEEL A4</p>	<p><b>LAG EYE SCREW</b></p> <p>316</p>  <p><b>HES16PL</b></p> <p>316 STAINLESS STEEL A4</p>
<p><b>WIRE ROPE THIMBLE CLOSED</b></p> <p>304</p>  <p><b>HXTH04N</b></p> <p>304 STAINLESS STEEL A2</p>	<p><b>WIRE ROPE THIMBLE OPEN</b></p> <p>304</p>  <p><b>HXTH04O</b></p> <p>304 STAINLESS STEEL A2</p>	<p><b>MACHINE FERRULE</b></p>  <p><b>HXFEM</b></p> <p>NICKEL PLATED COPPER HEC</p>	<p><b>HAND FERRULE</b></p>  <p><b>HXFEH</b></p> <p>NICKEL PLATED COPPER HEC</p>	<p><b>SOCKET DRIVE FOR LAG SCREWS</b></p>  <p><b>HXSD</b></p> <p>MGAL HEC</p>		

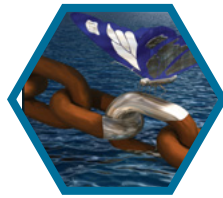

CROSS CONNECTOR		BLACK BUSH SPLIT TYPE		BEVELLED WASHER		KEY	
304						<b>KEY</b>	
	<b>HXCC04</b>		<b>HXNBB</b>		<b>HXWBBC</b>	<b>CHR</b> CHROME PLATE	
	304 STAINLESS STEEL A2		NYLON		CHROME BRASS HEC	<b>BRASS</b> BRASS	
WIRE ROPE SHELF SUPPORT CLIP		ROUND BALL INTERNAL THREADED		ROUND BALL		<b>MGAL</b> MECHANICAL GALVANISED	
316		316		316		<b>ALUM</b> ALUMINIUM	
	<b>HXSS16</b>		<b>HXRB16TM</b>		<b>HXRB16</b>	<b>NY UV</b> NYLON BLACK UV STABLE	
	316 STAINLESS STEEL A4		316 STAINLESS STEEL A4		316 STAINLESS STEEL A4	<b>SS</b> STAINLESS STEEL	
RETAINING CLIP		SADDLE EYE STRAP		WIRE ROPE GRIP		<b>STEEL</b> STEEL	
316		304		316			
	<b>HXRC</b>		<b>HED04ST</b>		<b>HXRW16G</b>		
	316 STAINLESS STEEL A4		304 STAINLESS STEEL A2		316 STAINLESS STEEL A4		
TIMBER INS CSK HEX SOCKET L/H		TIMBER INS CSK HEX SOCKET R/H		EYE SCREW METAL THREAD			
316		316		316		316	
	<b>HXTI16CLM</b>		<b>HXTI16CRM</b>		<b>HES16PCM</b>		<b>HXPINC</b>
	316 STAINLESS STEEL A4		316 STAINLESS STEEL A4		316 STAINLESS STEEL A4		316 STAINLESS STEEL A4
HEAD TENSIONER ALLEN KEY		HEAD TENSIONER HEX HEAD				<b>RIGGING SCREW SPANNER</b>	
304		304				<b>HXRSS</b>	
	<b>HXHT04AK</b>		<b>HXHT04HH</b>			<b>CHROME HEC</b>	
	304 STAINLESS STEEL A2		304 STAINLESS STEEL A2				

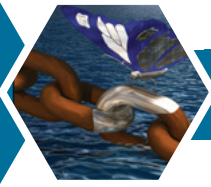

# Terminal Swages, Rigging Screws & Turnbuckles

**NEW RIGGING  
SCREW  
HOOK + JAW**

316

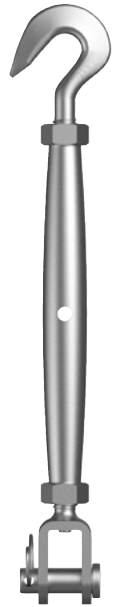

**HRS16HJ**

**316  
STAINLESS STEEL  
A4**

Stud

Swage

Screw

Hook









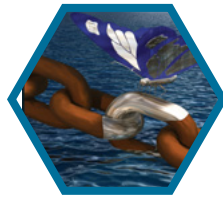





Eye

Jaw

Toggle





<p><b>RIGGING SCREW EYE + EYE</b></p> <p>316</p>  <p><b>HRS16EE</b></p> <p>316 STAINLESS STEEL A4</p>	<p><b>RIGGING SCREW LAG + SWAGE</b></p> <p>316</p>  <p><b>HRS16LS</b></p> <p>316 STAINLESS STEEL A4</p>	<p><b>RIGGING SCREW JAW + JAW</b></p> <p>316</p>  <p><b>HRS16JJ</b></p> <p>316 STAINLESS STEEL A4</p>	<p><b>RIGGING SCREW JAW + SWAGE</b></p> <p>316</p>  <p><b>HRS16JS</b></p> <p>316 STAINLESS STEEL A4</p>	<p><b>RIGGING SCREW TGLE + SWAGE</b></p> <p>316</p>  <p><b>HRS16TS</b></p> <p>316 STAINLESS STEEL A4</p>	<p><b>TERMINAL SWAGE INTERNAL THREADED</b></p> <p>316</p>  <p><b>HTS16IT</b></p> <p>316 STAINLESS STEEL A4</p>	<p><b>TERMINAL SWAGE LAG SCREW LEFT</b></p> <p>316</p>  <p>LEFT HAND</p> <p><b>HTS16LL</b></p> <p>316 STAINLESS STEEL A4</p>
<p><b>TERMINAL SWAGE LAG SCREW RIGHT</b></p> <p>316</p>  <p><b>HTS16RL</b></p> <p>316 STAINLESS STEEL A4</p>	<p><b>TERMINAL SWAGE STUD RIGHT HAND</b></p> <p>316</p>  <p><b>HTS16ST</b></p> <p>316 STAINLESS STEEL A4</p>	<p><b>TERMINAL SWAGE STUD LEFT HAND</b></p> <p>316</p>  <p>LEFT HAND</p> <p><b>HTS16SL</b></p> <p>316 STAINLESS STEEL A4</p>	<p><b>TURNBUCKLE OPEN BODY HOOK + EYE</b></p> <p>316</p>  <p><b>HTB16HE</b></p> <p>316 STAINLESS STEEL A4</p>	<p><b>TURNBUCKLE OPEN BODY HOOK + HOOK</b></p> <p>316</p>  <p><b>HTB16HH</b></p> <p>316 STAINLESS STEEL A4</p>	<p><b>TURNBUCKLE OPEN BODY JAW + JAW</b></p> <p>316</p>  <p><b>HTB16JJ</b></p> <p>316 STAINLESS STEEL A4</p>	<p><b>TURNBUCKLE OPEN BODY EYE + EYE</b></p> <p>316</p>  <p><b>HTB16EE</b></p> <p>316 STAINLESS STEEL A4</p>